



OWNER'S MANUAL
AND REFERENCE

GPSMAP 230



© 1999 - 2000 GARMIN Corporation

GARMIN International, Inc.
1200 East 151st Street, Olathe, Kansas 66062, U.S.A.
Tel. 913/397.8200 or 800/800.1020
Fax 913/397.8282

GARMIN (Europe) Ltd.
Unit 5, The Quadrangle, Abbey Park Industrial Estate, Romsey, SO51 9AQ, U.K.
Tel. 44/1794.519944
Fax 44/1794.519222

GARMIN (Asia) Corporation
No. 68, Jangshu 2nd Road, Shijr, Taipei County, Taiwan
Tel. 886/2.2642.9199
Fax 886/2.2642.9099

All rights reserved. Except as expressly provided herein, no part of this manual may be reproduced, copied, transmitted, disseminated, downloaded or stored in any storage medium, for any purpose without prior written consent of GARMIN Corporation. GARMIN Corporation hereby grants permission to download a single copy of this manual onto a hard drive or other electronic storage medium to be viewed for personal use, provided that such electronic or printed copy of this manual contains the complete text of this copyright notice and provided further that any unauthorized commercial distribution of this manual is strictly prohibited.

Information in this manual is subject to change without notice. GARMIN Corporation reserves the right to change or improve its products and to make changes in the content without obligation to notify any person or organization of such changes. Visit the GARMIN website (www.garmin.com) for current updates and supplemental information concerning the use and operation of this and other GARMIN products.

GARMIN and GPSMAP 230 are registered trademarks of GARMIN Corporation and may not be used without the express permission of GARMIN Corporation.



INTRODUCTION

Foreword

Help us better support you by completing our on-line registration today! Have the serial number of your GPSMAP 230 handy and connect to our website (www.garmin.com). Look for the Product Registration link on the Home page.

Why should you register your GPSMAP 230?

- Notification of Product Updates
- Notification of New Products
- Lost or Stolen unit tracking

NOTE: If you have previously registered your GARMIN product purchase using a mail-in registration card, we invite you to re-register using our NEW on-line system. Many services provided by our new product registration system are now being automated and re-registering your purchase ensures you the best possible support from GARMIN.

Software Version .4.03 or above

Internal Database Version 2.01

© Navionics Corporation

G-chart™ cartridge data is copyrighted by Navionics Corporation and GARMIN Corporation and may not be copied or used for any other purpose without permission.

GARMIN™, G-chart™, AutoLocate™, TracBack™ and PhaseTrac12™ are trademarks of GARMIN Corporation and may only be used with permission. All rights are reserved.



INTRODUCTION

Cautions

CAUTION!

The GARMIN GPSMAP 230 has no user-serviceable parts. Should you ever encounter a problem with your unit, please take it to an authorized GARMIN dealer for repairs.

CAUTION

The GPS system is operated by the United States government, which is solely responsible for its accuracy and maintenance. The system is subject to changes which could affect the accuracy and performance of all GPS equipment. Although the GARMIN GPSMAP 230 is a precision electronic NAVigation AID (NAVAID), any NAVAID can be misused or misinterpreted and, therefore, become unsafe.

Use the GPSMAP 230 at your own risk. To reduce the risk of unsafe operation, carefully review and understand all aspects of this Owner's Manual—and thoroughly practice operation using the simulator mode prior to actual use. When in actual use, carefully compare indications from the GPSMAP 230 to all available navigation sources, including the information from other NAVAIDs, visual sightings, charts, etc. For safety, always resolve any discrepancies before continuing navigation.

NOTE: This equipment generates, uses, and can radiate radio frequency energy and, if not installed and used in accordance with the instructions, may cause harmful interference to radio communications. However, there is no guarantee that interference will not occur in a particular installation. If this equipment does cause harmful interference, the user is encouraged to try to correct the interference by relocating the equipment or connecting the equipment to a different circuit. Consult an authorized dealer or other qualified technician for additional help if these remedies do not correct the problem.

This device complies with Part 15 of the FCC limits for class B digital devices for home or office use. Operation is subject to the following conditions: (1) This device may not cause harmful interference, and (2) this device must accept any interference received, including interference that may cause undesired operation.

The GPSMAP 230 contains no user-serviceable parts. Repairs should only be made by an authorized service center. Unauthorized repairs or modifications could void your warranty and your authority to operate this device under Part 15 regulations.



INTRODUCTION

Capabilities

Designed for detailed electronic charting and simple operation, the GARMIN GPSMAP 230 is a powerful navigation device that can help guide you in waterways around the world:

Precision Performance

- 7" High-contrast 4-level gray LCD screen
- PhaseTrac12™ receiver tracks and uses up to 12 satellites simultaneously for fast, accurate positioning
- Differential-Ready— just add the optional GBR 21 beacon receiver for better than 10-meter accuracy
- Gasketed case for use in exposed locations

Advanced Navigating and Plotting

- 250 alphanumeric waypoints with selectable icons and comments
- Built-in worldwide database usable from 4096 to 64 nm scales
- 20 reversible routes with up to 30 waypoints each
- G-chart™ electronic charting with inland and offshore coverage
- On-screen point-to-point distance and bearing calculations
- TracBack™ route feature which allows you to quickly retrace your track log to a starting position
- Built-in simulator mode



INTRODUCTION

Warranty

LIMITED WARRANTY

GARMIN Corporation warrants this product to be free from defects in materials and manufacture for one year from the date of purchase. GARMIN will, at its sole option, repair or replace any components that fail in normal use. Such repairs or replacement will be made at no charge to the customer for parts or labor. The customer is, however, responsible for any transportation costs. This warranty does not cover failures due to abuse, misuse, accident or unauthorized alteration or repairs.

THE WARRANTIES AND REMEDIES CONTAINED HEREIN ARE EXCLUSIVE AND IN LIEU OF ALL OTHER WARRANTIES EXPRESS OR IMPLIED OR STATUTORY, INCLUDING ANY LIABILITY ARISING UNDER ANY WARRANTY OF MERCHANTABILITY OR FITNESS FOR A PARTICULAR PURPOSE, STATUTORY OR OTHERWISE. THIS WARRANTY GIVES YOU SPECIFIC LEGAL RIGHTS, WHICH MAY VARY FROM STATE TO STATE.

IN NO EVENT SHALL GARMIN BE LIABLE FOR ANY INCIDENTAL, SPECIAL, INDIRECT OR CONSEQUENTIAL DAMAGES, WHETHER RESULTING FROM THE USE, MISUSE, OR INABILITY TO USE THIS PRODUCT OR FROM DEFECTS IN THE PRODUCT. SOME STATES DO NOT ALLOW THE EXCLUSION OF INCIDENTAL OR CONSEQUENTIAL DAMAGES, SO THE ABOVE LIMITATIONS MAY NOT APPLY TO YOU.

To obtain warranty service, call the GARMIN Customer Service department (913-397-8200) for a returned merchandise tracking number. The unit should be securely packaged with the tracking number clearly marked on the outside of the package and sent freight prepaid and insured to a GARMIN warranty service station. A copy of the original sales receipt is required as the proof of purchase for warranty repairs. GARMIN retains the exclusive right to repair or replace the unit or software or offer a full refund of the purchase price at its sole discretion. SUCH REMEDY SHALL BE YOUR SOLE AND EXCLUSIVE REMEDY FOR ANY BREACH OF WARRANTY.

PREFACE

Congratulations on choosing one of the most advanced marine navigation systems available! The GARMIN GPSMAP 230 combines the proven performance of GARMIN GPS with powerful G-Chart electronic charting for detailed cartography and plotting wherever you cruise.

To get the most out of your new navigation system, take the time to go through this operator's manual and learn the operating procedures for your unit. This manual is broken down into two sections for your convenience.

Getting Started introduces you to the GPSMAP 230 and provides a tutorial that will help you become more familiar with the unit. This part will provide you with a basic working knowledge necessary to use the unit to its fullest potential.

The **Reference** portion is divided into sections that provide detailed instructions on the advanced features and operations of the GPSMAP 230. This allows you to concentrate on a specific topic quickly, without reading through entire portions of text that you may not need.

An **Appendix** section concludes the manual with specific information needed for custom setup, trouble shooting, and indexing.



INTRODUCTION

Preface

WARNING!

The electronic chart is an aid to navigation and is designed to facilitate the use of authorized government charts, not replace them. Only official government charts and notices to mariners contain all information needed for the safety of navigation—and, as always, the user is responsible for their prudent use.



INTRODUCTION

Packing List

Before installing and getting started with your unit, please check to see that your package includes the following items. If any parts are missing, please see your GARMIN dealer immediately.

Standard Package:

- GPSMAP 230 Unit
- External Antenna and 30' cable
- Power/Data Cable
- Mounting Bracket and Knobs
- Owner's Manual
- Quick Reference Card

Optional Accessories:

- G-chart Electronic Chart Cartridges
- PC Kit

Foreword	i
Cautions	ii
Capabilities/Warranty	iii-iv
Preface/Packing List	v-vi
Table of Contents/Keypad Usage	vii-x
Getting Started	1-16
Initializing the Receiver	1-2
Turning the Unit On & Screen Contrast	3
Satellite Page Intro & Position Page Intro	4-5
Marking Your Present Position	6
Map Page Introduction	7
Using the Cursor	8
Going to a Destination & Activating a Route	9
Navigation Simulator & Map Scale Intro	10
Using the Cursor to Pan and Mark Waypoints	10-11
Navigation Page Intro	12
Changing Simulated Speed & Direction and Highway Scales/Data Fields	13
Active Route Page & Deactivating a Route	14
Main Menu Intro & Deleting the Track Log	15
Turning the Unit Off	16
Section 1: GPSMAP Status Page	17-19
Satellite Page Overview	17
Satellite Status	18
Satellite Page Options	19
Section 2: Position Page	20-21
Position Page Overview	20
Position Page Options	21



GETTING STARTED

Table Of Contents

Section 3: Map Page	22-29
Map Page Overview & Data Window	22
Map Modes	
Position Mode & Cursor Mode	23
Using the Cursor	24
Selecting Map Scales	
“Over Zoom” & “No Map”	25
Map Page Options	26
Map Configuration	27-28
Map Colors	28
Map Display & Data Fields	29
Section 4: Navigation Page	30-32
Navigation Page Overview	30
Highway Scale & Navigation Page Options	31-32
Section 5: Main Menu Page	33
Main Menu Page Overview	33
Section 6: Waypoints	34-42
Creating Waypoints & Using the Mark Key	34-35
Creating Waypoints On Map & By Text	36
Reference Waypoints	37
Reviewing and Editing Waypoints by Text	38
Waypoint Definition Page Options	39
Waypoint Submenus & Nearest Waypoints	40
Proximity Waypoints	41
Create Waypoint & Waypoint List	42
Section 7: GOTO/MOB/TracBack Functions	43-46
Selecting A GOTO	43
GOTO Key	44
MOB & TracBack Navigation	45-46



GETTING STARTED

Table Of Contents

Section 8: Routes	47-54
Creating a Route On Map	47
Reviewing and Editing Routes On Map	48
Route Edit Mode	49-50
Route Edit Options	50
Route List Page Options	51-52
Active Route Page	53
Active Route Page Options	54
Section 9: Setup Menus	55-64
Track Log Setup	55
Trip and Fuel Planning	56
Route and Trip Planning	57
Sunrise & Sunset Planning	58
System Setup	58-59
Navigation Setup	60-61
Timers & Alarms	62
Input & Output Setup	63
NMEA & DGPS Setup	64
Section 10: Using G-chart cartridges	65-66
Installing and Removing G-Charts	65
Using G-Chart Cartridges	66

APPENDICES

Appendix A:

GPSMAP 230 Installation	67-69
-------------------------------	-------

Appendix B:

Wiring & Specifications	70-71
-------------------------------	-------

Appendix C:

Messages	72-73
----------------	-------

Appendix D:

Map Datums	74-76
------------------	-------

Appendix E:

Navigation Terms	77-78
------------------------	-------

Appendix F:

Time Offset Chart	79
-------------------------	----

Appendix G:

Loran TD Position Format	80
--------------------------------	----

Appendix F:

Index	81-84
-------------	-------











INTRODUCTION

Keypad Usage

The GPSMAP 230's advanced keypad system is designed to allow for fast, convenient selection of navigation options and data entry.

The Getting-Started Tour will introduce you to most of the keypad and provide a "hands-on" lesson in using the GPSMAP 230. We strongly encourage you to take the Getting-Started tour before using your unit for actual navigation.

The GPSMAP 230 Quick Reference Card contains helpful tips on using the unit and performing various navigation tasks. It's a good idea to keep the Quick Reference Card nearby whenever you're navigating with your new GPS chartplotter.

	Turns the unit on and off and controls 3-level screen backlighting.
	Scrolls the main pages in sequence and returns display from a submenu page to a main page.
	Captures your present position and displays the mark position window.
	Displays the GOTO waypoint window, allowing you to select the destination waypoint. Press GOTO twice to select a destination waypoint from the map.
	Displays context-sensitive options window. Press MENU twice to display main menu page.
	Activates highlighted fields and confirms menu options and data entry.
	Returns display to a previous page or restores a data field's previous value.
	Decreases the scale of the moving map and highway pages.
	Increases the scale of the moving map and highway pages.
	Controls the movement of the cursor and is used to select options and positions, and to enter data.
	Marks your present GPS position and instantly sets a return course while providing steering guidance.

Initializing the Receiver

The first time you power up your new GPSMAP 230 is an important step in getting the best possible GPS performance. The receiver must be given an opportunity to collect satellite data and establish its present position. To ensure proper initialization, the GPSMAP 230 is shipped from the factory in AutoLocate™ mode, which will allow the receiver to “find itself” anywhere in the world. To speed up the initialization process, we recommend using the graphic initialization process described below, which will usually provide a position fix in about a minute.

Before you initialize, make sure the GPSMAP unit and antenna have been correctly installed on your vessel according to the instructions in Appendix A.

To turn the GPSMAP 230 on:

1. Press and hold the  key until the power tone sounds.



The welcome page will appear while the unit conducts a self test. Once the internal test is complete, the mariner's warning will appear, asking you to read and acknowledge important information regarding the proper use of electronic charts.

To acknowledge the mariner's warning:

1. Press the  key.

A message alert and prompt will also appear to ask you to select an initialization method.

To view a message:

1. Press the  key.
2. Press the  key again to return to the previous page.

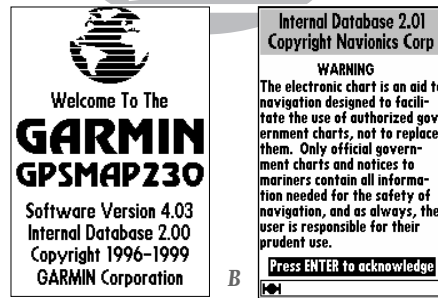

- A. The welcome page will be displayed while the unit performs a self-test.
- B. Confirm the mariner's warning before starting navigation. Remember that the electronic chart is designed as a supplement to local government charts, not as a replacement.

GETTING STARTED

Initialization

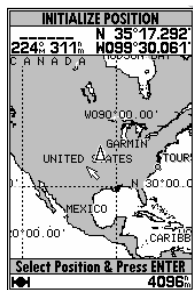

A

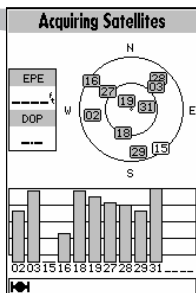

B

A. Use the arrow keypad to move the cursor to a location close to your present position.

B. Hollow signal strength bars will appear on the Satellite Page while the receiver collects satellite data.

The select initialization window will appear, with the 'select from map' option highlighted.

1. Press **EDIT** to initialize the receiver from the built-in worldwide map.

The Map Page will appear, prompting you to select your approximate present position with the map cursor.

1. Use the **▲** keypad to move the map cursor to a location close to your present position. If you have difficulty identifying your exact position, press the **IN** key to zoom in to a lower map scale.

2. Press **EDIT** to confirm your selection.

The GPSMAP 230 will now begin searching for the appropriate satellites for your present position and should acquire a fix within a minute or so. While the receiver searches for satellites, a flashing satellite icon will appear at the left-hand side of the status bar. A signal strength bar will also appear for each satellite in view, with the appropriate satellite number under each bar. The progress of satellite acquisition is shown in three stages:

- **No signal strength bars**— the receiver is looking for the satellites indicated.
- **Hollow signal strength bars**— the receiver has found the indicated satellite(s) and is collecting data.
- **Solid signal strength bars**— the receiver has collected the necessary data and the satellite(s) is ready for use.

Once the receiver has collected information from at least three satellites, the flashing satellite icon on the status bar will quit flashing and remain solid, and the GPSMAP 230 is ready for use.

Now that the unit is initialized, let's turn the unit off and then begin the Getting-Started Tour.

To turn the GPSMAP 230 off:



1. Press and hold the **OFF** key for about 3 seconds, until the screen is blank.

GPSMAP 230 Getting-Started Tour

The GARMIN GPSMAP 230 is a powerful electronic charting/navigating system that provides detailed chart coverage and convenient control of many advanced features right from the map display. This tour is designed to take you through the basic pages and functions of the system using the simulator mode. Once you're familiar with the main pages and functions of the unit, refer to the reference section for instructions on performing specific tasks and functions.



The Getting-Started Tour assumes that the receiver has been properly installed and initialized, and you have not changed any of the default unit settings. If you have changed any settings (position formats, units of measure, etc.), the descriptions and pictures in the tour may not match your configuration.

To turn the GPSMAP 230 on:

1. Press and hold the  key until the power tone sounds. The welcome page will appear while the unit conducts a self test.
2. Once the self test is complete, press the  key to acknowledge the mariner's warning.

The Satellite Page will appear, and the receiver will begin to acquire satellites. From the Satellite Page, you may also quickly adjust the screen contrast and backlighting.

To adjust the screen contrast:

1. To increase the screen contrast, press the right arrow of the  keypad.
2. To decrease the screen contrast, press the left arrow of the  keypad.
3. Press the  key to finish.

The GPSMAP 230's three-level screen backlighting is controlled with  key, and may be adjusted at any time from any page.

To turn on and adjust the backlighting:

1. Press the  repeatedly until the backlighting is at the desired level (off, 1, 2, or 3).

GETTING STARTED

Power On & Screen Contrast

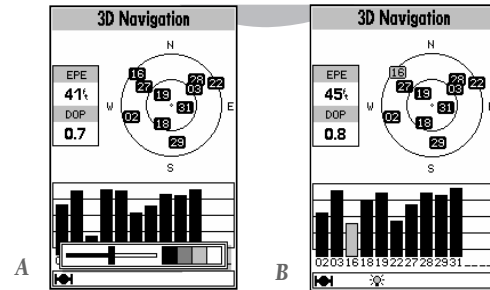

- A. The screen contrast may be adjusted from the Satellite Page by pressing the ARROW KEYPAD. Press EDIT/ENTER to confirm changes.
- B. Whenever the screen backlighting is on, a bulb icon will appear in the status bar at the bottom of every GPSMAP 230 page.

GETTING STARTED

Satellite Page & Simulator Mode



A

A. To start the simulator, confirm the simulator warning. Simulator mode should never be used for actual navigation.

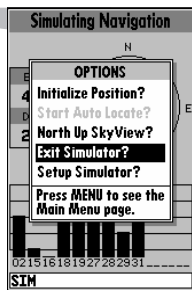

B

B. Whenever the GPSMAP 230 is in simulator mode, a 'Setup Simulator?' and an 'Exit Simulator?' option will appear on the options page.

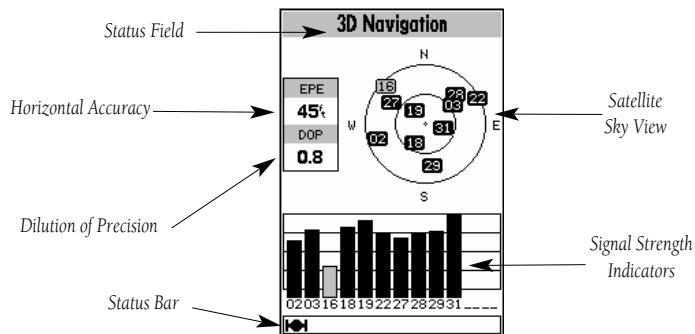

The GPSMAP 230's **Satellite Page** provides a visual reference of satellite acquisition and receiver status, with a signal strength bar graph and a satellite sky view in the center of the page. Each page of the GPSMAP 230's system also features an options page, which gives you access to other functions and features that relate to the specific page you are viewing. To get a feel for how the options pages work, lets put the GPSMAP 230 into simulator mode.

To place the GPSMAP 230 in simulator mode:

1. From the Satellite Page, press the **MENU** key. The options page will appear, displaying a menu of options and functions for the Satellite Page.
2. Use the UP or DOWN arrow of the **⬇** keypad to highlight the 'Start Simulator?' option and press **EDIT ENTER**.
3. Press the **EDIT ENTER** key to confirm the simulator warning.

Once the simulator has been started, the status field at the top of the page will display a 'Simulating Navigation' status, and you're ready to continue the rest of the tour. Keep in mind that the GPSMAP 230 does not track satellites in simulator mode, and should never be used for actual navigation. All the waypoint and route planning done in simulator mode will still be retained in memory for future use.

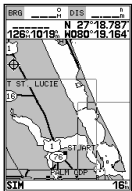
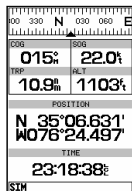
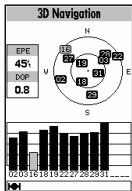

GETTING STARTED

Page Sequence & Position Page

The Satellite Page is one of four main pages used in the GPSMAP 230's system. All four pages are linked together in a simple chain, which allows you to scroll through the pages in either direction using the **PAGE** and **QUIT** keys. To continue the tour, let's move on to the next page, the Position Page.

To scroll to the next page in sequence:

1. Press the **PAGE** key.

The GPSMAP 230's **Position Page** shows where you are, what direction you're heading and how fast you're going. The compass tape at the top of the page indicates the direction you're moving. The four user-selectable data fields below the compass tape show your current course and speed over ground, along with a resettable trip odometer and altitude display. Your current latitude and longitude, along with a 12/24-hour clock, appear at the bottom of the page.

Now that you've seen how the Satellite and Position Pages can be used to monitor satellite acquisition and your present position, let's take a minute to learn how to mark and store our present position as a waypoint. (Since we're in simulator mode, the present position displayed will be the last position calculated by the receiver, which should be the spot where you've initialized the unit.) This will also give you an opportunity to see how the GPSMAP 230's **EDIT** key and **ENTER** key are used for data entry.

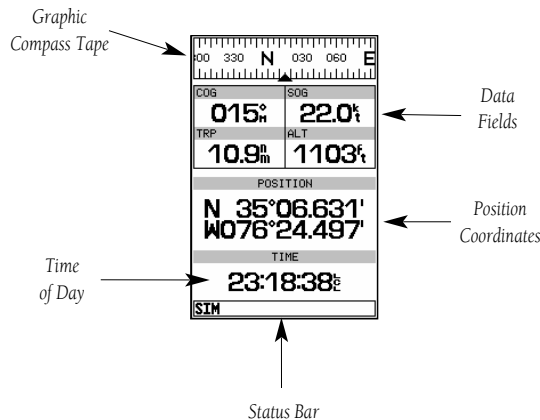

GETTING STARTED

Marking A Position

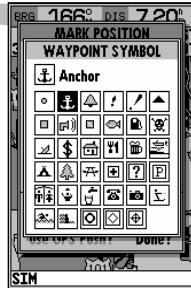
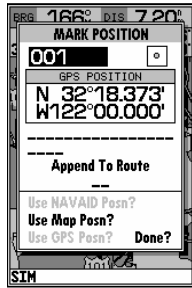

A

B

- A. The mark position page will automatically assign a default three-digit name for each waypoint, which can be changed at any time to an alphanumeric name containing up to six-characters.
- B. A complete set of waypoint symbols allows you to mark inland and offshore waypoints with a custom icon for fast waypoint recognition.

To mark your present position:

1. Press the **MARK** key. The mark position page will appear, with a default three-digit waypoint name and symbol.
2. Use the **0** keypad to highlight the waypoint name field (001) and press **EDIT ENTER**.
3. Press the LEFT ARROW of the **0** keypad to clear the name field.



4. Use the **0** keypad to enter the name 'DOCK', using the UP and DOWN arrows to select each letter, and the RIGHT arrow key to advance to the next character position. If you make a mistake and select an incorrect character, simply use the LEFT arrow key of the **0** keypad to backspace the cursor and correct the entry.
5. Press **EDIT ENTER** to confirm the name.
6. The field highlight will advance to the symbol field. Press **EDIT ENTER** to access the waypoint symbol page.
7. Use the **0** keypad to highlight the ANCHOR symbol.
8. Press **EDIT ENTER** to confirm the symbol.
9. Press **EDIT ENTER** again to confirm the 'DONE?' prompt and save the waypoint.

The waypoint is now stored in memory. Note that waypoints may also be created directly from the map display or by manually entering position coordinates. Both of these techniques are described in the reference section of the manual and/or on your GPSMAP 230 quick reference guide. To continue our tour, let's move on to the Map Page.

1. Press the **PAGE** key.

GETTING STARTED

Map Page

The GPSMAP 230's **Map Page** combines digital chartplotting with a user-selectable display of navigation data and a built-in worldwide database to 64 nm. It will also be the page you use most to create and edit waypoints and routes. Before we take off on our practice route, let's take a brief look at its various features and displays.

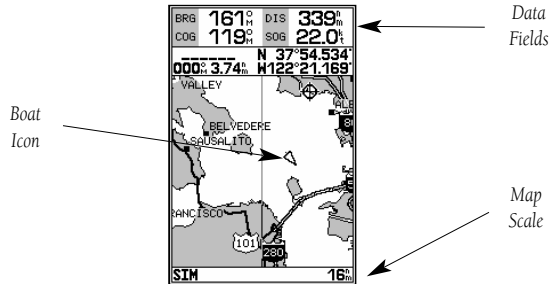

The **map display**, located in the middle of the page, shows your boat as a triangle marker on an electronically generated chart, along with geographic names, markers and buoys that are provided by the G-chart cartridge you're currently using. It also displays your track, routes and nearby waypoints. An on-screen **cursor** lets you pan to other map areas, determine the range and bearing to a position, and perform various waypoint and route functions.

The **data window**, located at the top of the page, provides a user-selectable display of various navigation data, including course, speed over ground, and the bearing and distance to the cursor or a particular waypoint. The status bar, located at the bottom of the page, displays the current map scale setting, as well as the status information described on page 17.

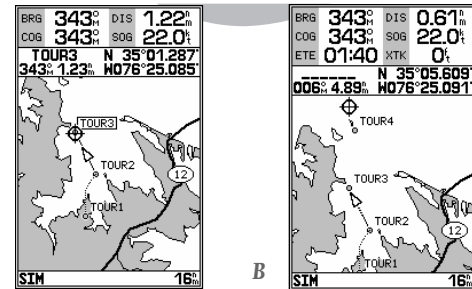

- To select an on-screen waypoint, simply move the cursor over the desired waypoint. The waypoint/navaid name and position, along with the bearing and distance from your present position, will be displayed.
- The map page can also be configured to display additional data fields and a graphic course deviation scale or compass. See page 26 for more on map options.

GETTING STARTED

Using the Map Cursor

Using the Map Cursor

Working from the Map Page is a simple process that centers around the use of the cursor. Controlled by the **ENTER** keypad, the cursor is an important tool that can be used to pan to other map locations, mark and edit waypoints and routes, and review position data of on-screen nav aids and waypoints.

To get a feel for using the Map Page and using the cursor, try the following exercise:

1. Use the **IN** key to set the map scale to the 64 nm setting. Your boat should be near the center of the map, at the receiver's last known position (if your boat isn't where it should be, make sure that you have initialized the receiver and acquired a position as described on pages 1-2).
2. Use the DOWN arrow of the **ENTER** keypad to move the cursor down to the first lat/lon grid south of your boat's position.
3. Using the **ENTER** keypad to move the cursor, try following the outline of the lat/lon grid closest to your boat. Notice how another data field appears at the top of the page, showing the bearing and distance from your boat to the cursor, along with the lat/lon of the cursor.
4. Press the **QUIT** key to remove the cursor and recenter your boat on the map display.

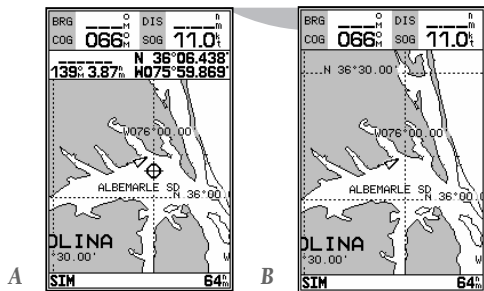

- A. Whenever the cursor is active, the bearing and distance of the cursor from your present position will appear in a pop-up data window.*
- B. To remove the cursor and recenter your vessel on the map, press the QUIT key.*

As you become more familiar with the cursor, you'll see that the map display actively scrolls or "pans", letting you explore areas around the world (even outside of your current G-chart™ coverage) and create waypoints and routes. Wherever you move the cursor, pressing **QUIT** once will return the map to your present position.

Now that you have a feel for how the cursor works, let's move on and see how the GPSMAP 230 works on the water. To help you practice using the Map Page and other features, we've stored a practice route in the receiver's permanent memory, so you can see exactly what you'll experience when you're navigating with your new GPS chartplotter.

Going to a Destination

GPS is all about marking positions as waypoints and navigating to them using the receiver's steering guidance and map displays. We've already seen how to use the **MARK** key to store our present position, so it's time to move on to the fun part—going to a destination. The **GOTO** key, located on the left side of the keypad above the **QUIT** key, is the primary tool used to select a destination waypoint or a route to navigate. The **GOTO** key can be used in three primary ways:

- Pressing **GOTO** once displays a list of all waypoints in memory, from which you can select a single destination waypoint.
- Pressing **GOTO** followed by the **MENU** key provides a list of GOTO options that lets you start a TracBack™ route, select a destination waypoint from the nearest waypoints list, select a stored route to navigate, or cancel the current GOTO destination.
- Pressing **GOTO** twice allows you to select an on-screen waypoint, navaid or cursor position as a destination directly from the map display.

For our simulated trip, we're going to select the preprogrammed tour route (the second method), which will automatically place our vessel at the first route waypoint. This will also give us an idea of how the **MENU** key is used throughout the GPSMAP 230 system to provide context-sensitive options and functions. Let's give it a try by activating the practice route stored in memory for navigation:

1. Press **GOTO**. The waypoint list page will appear (if we were selecting a single waypoint to navigate to rather than a route, we would highlight the waypoint and press **EDIT/ENTER**).
2. Press **MENU** to display the context-sensitive options available for the GOTO function.
3. Use the **6** keypad to highlight the 'Select Route?' option. Press **EDIT/ENTER** to confirm.
4. The select route page will appear, with the 'GPSMAP TOUR' route highlighted.
5. Press **EDIT/ENTER**. The Map Page will reappear and display five waypoints chained together in a simple route, with your boat at the first route waypoint.

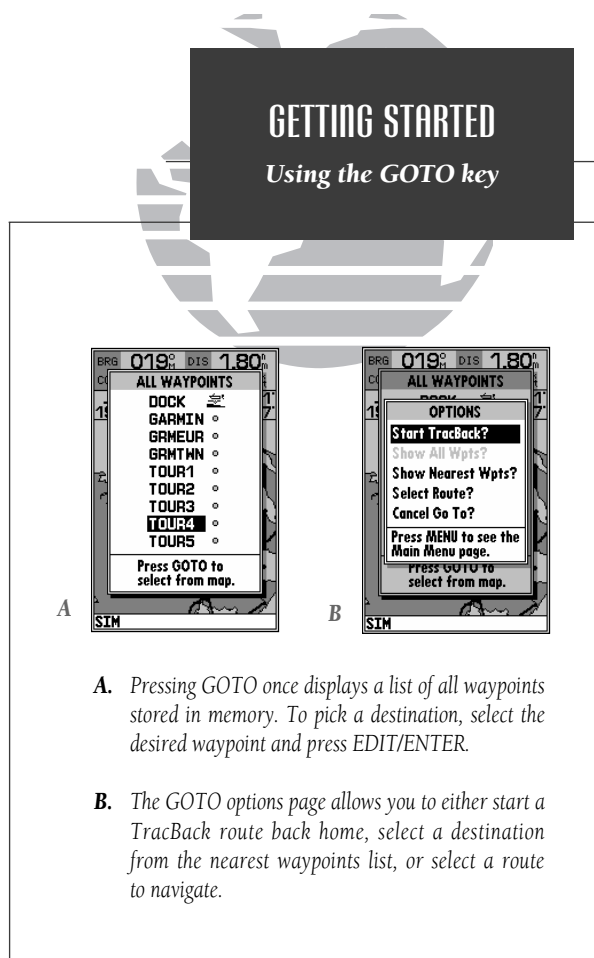

GETTING STARTED

Simulator Setup & Map Scales

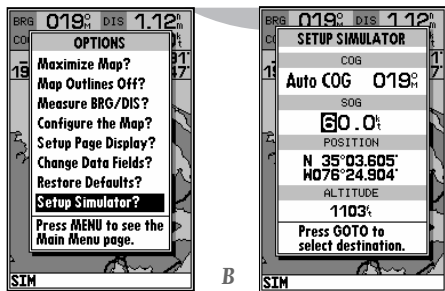

- A.** To enter a boat speed or define the simulated course, highlight the ‘Setup Simulator?’ option and press **EDIT/ENTER**.
- B.** Enter a boat speed of 60 knots to begin the tour. This will allow you to complete the Getting-Started Tour in 10-15 minutes.

A **data field** at the top of the page will now display the bearing and distance to the second route waypoint. To get started, let’s enter a speed for our vessel, which we can do from the ‘Setup Simulator?’ listing on the options page. The **setup simulator page** is also available from any other page in the main page sequence.

To enter a boat speed:

1. Press the **MENU** key to display the map options page.
2. Use the **0** keypad to select the ‘Setup Simulator?’ option and press **EDIT/ENTER**.
3. Once the setup simulator page appears, press **EDIT/ENTER** to access the SOG field.
4. Use the **0** keypad to enter a speed of 60 knots.
5. Press **EDIT/ENTER** to finish, and **PAGE** to return to the map display.

Once a speed has been entered, you’ll notice that the map will begin to move slowly, keeping your boat centered on the display. To get a better view of what’s going on, zoom in to a closer map scale.

1. Press the **IN** key to select the 16 nm scale.

You’ll now have a clearer picture of the route we are navigating, along with an outline-only presentation of the surrounding shoreline. Because the usable range of the built-in database is only valid to 64 nm scale, we no longer have full cartography available. Keep in mind that whenever you do exceed the usable range of the built-in database or the G-chart cartridge in use, the range field will display ‘OVR ZM’ or ‘NO MAP’ to indicate that you should exercise extreme caution using the cartography data. See page 25 and 66 for more information on map scales and using G-chart detailed cartography.

Now that we’re zoomed in a little closer to our route, we can pan ahead of our vessel with the cursor to review and create on-screen waypoints and nav aids. Try moving the cursor to select the ‘TOUR3’ waypoint— just use the **0** keypad to move the cursor as close as possible to the waypoint (to move the cursor in small increments, try a series of short key presses).

Once the cursor is over the TOUR3 waypoint, you'll notice that the waypoint symbol and name will become highlighted, and the data field at the top of the page will display the waypoint name, the range and bearing from your present position, and the coordinates for the waypoint.

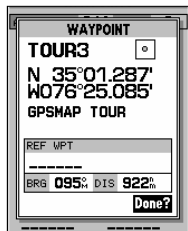

To review the waypoint page for a selected waypoint:

1. Press the **EDIT/ENTER** key.
2. To return to the Map Page, press **EDIT/ENTER** again.

The cursor can also be used to create new waypoints right from the map display.

To create a new waypoint using the cursor:

1. Use the **⬇️** keypad to move the cursor as close as possible to the following position: N 35° 02.129'; W 076° 26.106' (use the data window to verify the cursor position).
2. Press the **EDIT/ENTER** key to capture the cursor position.
3. Use the **⬇️** key to highlight the waypoint symbol field.
4. Press **EDIT/ENTER** to access the symbol page.
5. Press the DOWN arrow of the **⬇️** keypad twice to select the wreck symbol.
6. Press **EDIT/ENTER** to confirm, and **EDIT/ENTER** again to finish.

GETTING STARTED

Reviewing & Creating Waypoints on the Map

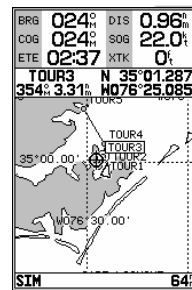

A

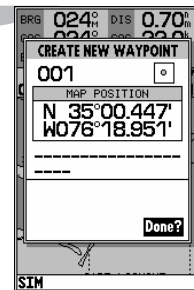

B

- A. Waypoints can be created from the map display by moving the cursor to the desired position and pressing the **EDIT/ENTER** key.
- B. The create new waypoint page will automatically assign the next available three-digit number as the default waypoint name. If you are creating a waypoint at an on-screen navaid, the navaid icon and name will be used as the default symbol and comment.

GETTING STARTED

Navigation Page

Now that we're navigating to an actual destination, let's move on to the next page of the GPSMAP 230 system, the **Navigation Page**:

1. Press the **PAGE** key.

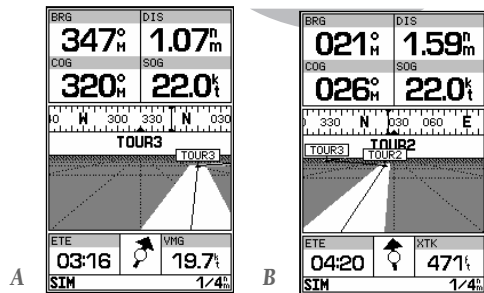
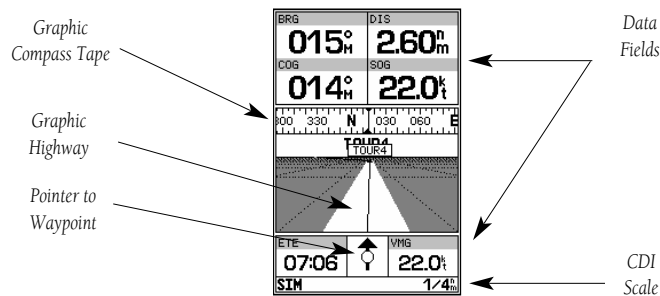

The Navigation Page provides graphic steering guidance to your destination. The **bearing (BRG)** and **distance (DIS)** to the destination, with your current **course (COG)** and **speed over ground (SOG)**, are displayed at the top of the page, along with a graphic compass to indicate your cardinal heading. The **estimated time enroute (ETE)** and **velocity made good (VMG)**, or the rate you are closing in on your destination) are displayed at the bottom of the page.

As you head toward the destination, the middle section of the page gives you visual guidance to your waypoint on a **graphic highway**, which displays the route and nearby waypoints on screen. The moving arrow below the highway always points to the destination waypoint relative to the direction you're moving. The line down the center of the highway represents your desired track, while the bottom of the page provides a graphic indication of your **cross-track error** (the distance and direction you are off course) according to the scale at the bottom right of the page.

A. In this example, our boat is off course to the left by about 1/16th of a mile (the base of the highway map is equal to the scale selected at the bottom right of the page). To get back on course, steer right.

B. In this example, our boat is off course to the right. To get back on course, steer left. A digital readout of your exact cross-track error can be displayed in any of the six data fields (see page 29).

Whenever the GPSMAP 230 is in simulator mode, you can adjust your speed and course from the Navigation Page using the  keypad. As you head toward each waypoint in the tour route, try adjusting your boat speed and course to get a feel for how the highway works.

To adjust the simulated boat speed:

1. Press the UP arrow of the  keypad to increase the speed in 5 knot/kph/mph increments. Press the DOWN arrow to decrease the speed in the same increments.

To steer the boat:

1. Press the LEFT and RIGHT arrows of the  keypad.

Notice that as you get off course, the highway and waypoint pointer move to give you graphic guidance to get back on course. The base of the highway display also serves as a graphic course deviation indicator (CDI), relative to the scale setting shown at the bottom right of the page. The scale setting represents the total distance (or the width) of the base of the highway display. The default graphic highway setting is 1/4 nm, but can be set for a 1/2-, 1-, 2- or 4-nm range.

To change the highway scale display:

1. Press the **IN** or **OUT** key (OUT to increase, IN to decrease the scale).

The Navigation Page data fields may also be configured to display any of ten different navigation values. Let's change the VMG field to crosstrack error to provide a digital readout of the distance we're off course.

To change a data field:

1. Press the **MENU** key to display the Navigation Page options.
2. Highlight the 'Change Data Fields?' option and press **EDIT/ENTER**. The field highlight will now appear in the top-left data field (the BRG field).
3. Use the  keypad to move the field highlight to the VMG field and press **EDIT/ENTER**.
4. Highlight the 'XTE' option and press **EDIT/ENTER**, and press **QUIT** to finish.

GETTING STARTED

Using the Navigation Page

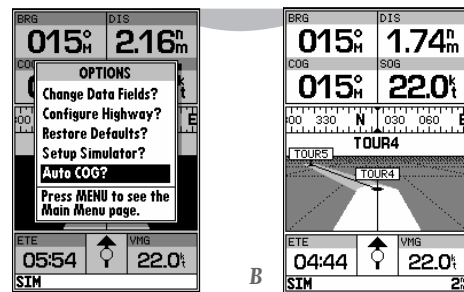

- A. To reset the simulator to steer the desired course automatically, select the 'Auto COG' setting from the options page.
- B. The highway scale can be set to a 1/4-, 1/2-, 1-, 2-, or 4-nm/mi/km range with the ZOOM keys.

GETTING STARTED

Active Route & Main Menu Page

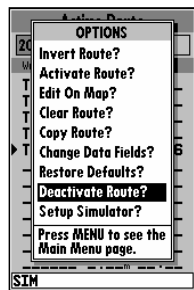

A

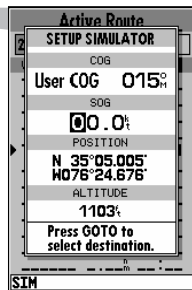

B

- A. To stop navigating the active route, select the 'Deactivate Route?' option and press EDIT/ENTER.
- B. Use the left arrow key to clear the SOG field and press EDIT/ENTER to confirm.

Now that you've seen the four main pages, let's review the **active route page**, which appears in the main page sequence whenever you are navigating a route:

1. Press the **PAGE** key.

The active route page shows each waypoint of the active route in sequence, with the waypoint name, distance and estimated time enroute to each waypoint displayed. As you navigate the route, the active route list will be automatically updated, indicating the next destination waypoint.

The active route page also provides quick access to many route activation, editing and copying functions you'll use most often, like inverting and deactivating the active route. Let's go ahead and deactivate the active route.

To deactivate the active route and stop navigation:

1. Press the **MENU** key.
2. Highlight the 'Deactivate Route?' option.
3. Press **EDIT/ENTER** to confirm.

To reset the boat speed to zero:

1. Press the **MENU** key.
2. Highlight the 'Setup Simulator?' option.
3. Press **EDIT/ENTER**.
4. Press **EDIT/ENTER** to access the SOG field.
5. Press the LEFT arrow of the **0** keypad to clear the speed entry.
6. Press **EDIT/ENTER**.

As you've seen, the GPSMAP 230's main pages provide vital status, position, navigation and map information. The last page we'll cover in the tour is the **main menu** page, which provides access to the GPSMAP 230's waypoint, route and planning functions, as well as various operational and navigation setup features. The Main Menu is available from any page, and is accessed through the **MENU** key.

To access the Main Menu Page:

1. Press the **MENU** key twice.

The Main Menu Page's 11 submenus are divided into categories by function. You can select a particular submenu by simply highlighting the desired option and pressing **EDIT/ENTER**. To get a feel for how the Main Menu Page works, let's clear out the track log we've created during our simulated tour. This will ensure that you have a clean slate once you start navigating in your home waters.

To select the track submenu:

1. Highlight the 'Track' menu option and press **EDIT/ENTER**.

The track log page allows you to specify whether to record a track plot and define how it is recorded. It also provides both an indicator of the total memory used and the individual functions to clear the track log and start a TracBack route.

To delete the track log:

1. Highlight the 'Delete Track' option and press **EDIT/ENTER**. A confirmation page will appear.
2. Highlight the 'Yes' prompt and press **EDIT/ENTER** to confirm.
3. Press **PAGE** to return to the main page sequence.

Congratulations! You've now gone through the basic operation of the GARMIN GPSMAP 230. Your new digital chartplotter is a powerful tool with many advanced features not covered in the Getting-Started Tour. For detailed instructions on using these features or performing a specific task, please refer to the quick reference guide or the appropriate reference section of this manual.

GETTING STARTED

Track Submenu & Clearing the Track Log

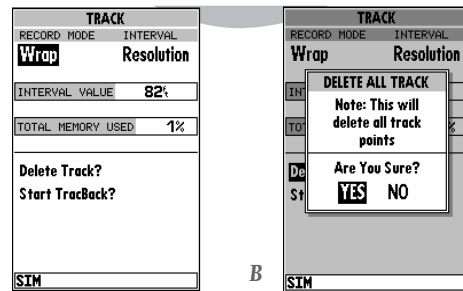

- A. The GPSMAP 230's track page lets you clear the track log and start a TracBack route.
- B. To delete the track log, confirm the warning page by highlighting the 'YES' prompt and pressing **EDIT/ENTER**.

GETTING STARTED

Power Off



To turn the GPSMAP 230 off:

1. Press and hold the  key for about 3 seconds, until the screen is blank.

Thank you for choosing the GARMIN GPSMAP 230 navigation system. We hope that it will be a useful tool for you wherever you travel.

Satellite Page

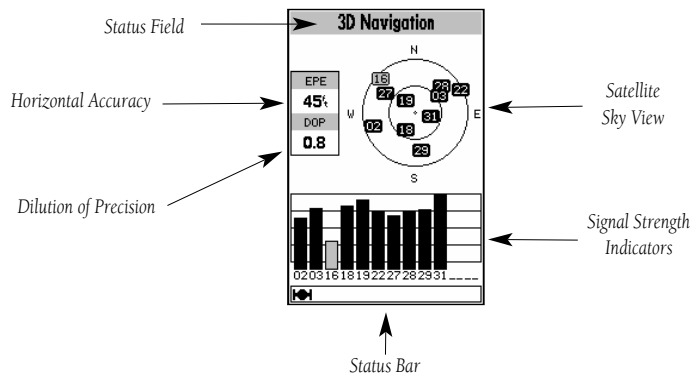

The GPSMAP 230 **Satellite Page** provides a visual reference of various receiver functions, including current satellite coverage, receiver operating mode and current receiver accuracy. The status information will give you an idea of what the receiver is doing at any given moment.

The **sky view** and **signal strength bars** give you an indication of what satellites are visible to the receiver and whether or not they are being tracked. The signal strength is shown on a bar graph for each satellite, with the satellite number below. When a satellite is visible but not being tracked, the strength bar will not be shown and the sky view indicator will not be highlighted.

The sky view shows a bird's-eye view of the position of each satellite relative to the receiver's last known position. The outer circle represents the horizon (track up), the inner circle is 45° above the horizon, and the center point is a position directly overhead. Use the sky view to determine if there are obstructions shading your reception of GPS signals.

SATELLITE PAGE

SECTION 1

Overview

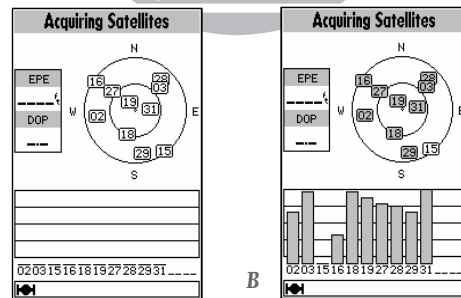

- Whenever the GPSMAP 230 is searching for satellites, no signal strength bars will appear.
- Once the receiver has found the satellite(s) indicated, a hollow signal strength bar will appear. After satellite data has been collected, the signal strength bars will become solid.

SECTION

1

SATELLITE PAGE

Receiver Status

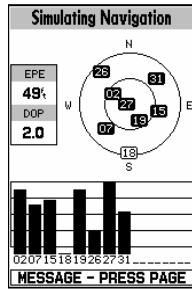

A

A. The status bar at the bottom of the page displays important status, alarm, and map scale information. It also provides on-screen user and message prompts.

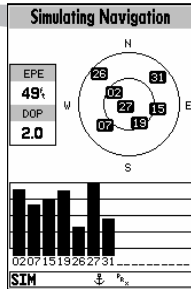

B

B. The status bar will display an anchor symbol or 'PRX' icon whenever the anchor drag alarm or proximity alarm has been triggered.

Receiver Status, EPE & DOP

Receiver status is indicated at the top of the page, with the current **estimated position error** (EPE) and **dilution of precision** (DOP) to the left of the sky view. DOP is an indication of satellite geometry quality measured on a scale of one to ten (lowest numbers the best, highest numbers the poorest). EPE uses DOP and other factors to calculate a horizontal position error in feet or meters. The status field will show one of the following conditions:

- **Searching the Sky**— the receiver is looking for any satellites.
- **AutoLocate**— the receiver is looking for any satellite whose almanac has been collected. This process can take up to five minutes.
- **Acquiring Satellites**— the receiver is looking for and collecting data from satellites visible at its last known or initialized position, but has not collected enough data to calculate fix.
- **2D Navigation**— at least three satellites with good geometry have been acquired and a 2 dimensional position fix (latitude and longitude) is being calculated. '2D Differential Navigation' will appear when you are receiving DGPS corrections in 2D mode.
- **3D Navigation**— at least four satellites with good geometry have been acquired and your position is now being calculated in latitude, longitude and altitude. '3D Differential Navigation' will appear when you are receiving DGPS corrections in 3D mode.
- **Poor GPS Coverage**— the receiver is no longer tracking enough satellites for a 2D or 3D fix.
- **Receiver Not Usable**— the receiver is unusable, possibly due to incorrect initialization or abnormal satellite conditions. Turn the unit off and back on to reset.
- **Simulating Navigation**— the receiver is in simulator mode.

Satellite Page Options

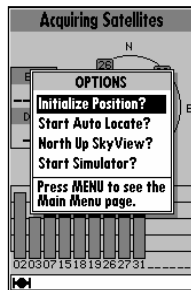

The GPSMAP 230's Satellite Page features a context-sensitive options page that provides access to functions and features relating to the Satellite Page.

To display the Satellite Page options:

1. Press **MENU**.

To select a menu option:

1. Highlight the desired option and press **EDIT ENTER**.

The following options are available:

- **Initialize Position?**— allows you to initialize the receiver on map or by text. See pages 1-2 for instructions on initialization.
- **Start AutoLocate?**— allows the receiver to locate your position automatically.
- **Track Up/North Up SkyView?**— allows you to select between a north or track up sky view display.
- **Setup Simulator?**— allows you to define speed, course, and position values while in simulator mode. See the Getting-Started Tour for more on using simulator mode.

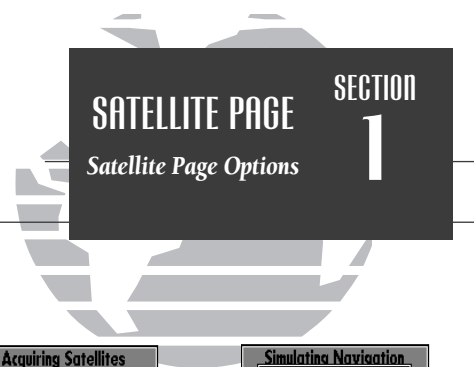

A

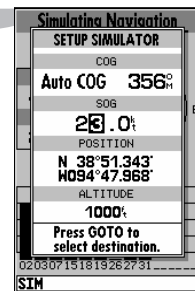

B

- A. Whenever the GPSMAP 230 is in simulator mode, the 'Setup Simulator?' option will appear on all the main pages.
- B. The setup simulator page allows you to define your speed and course over ground, as well as your position and altitude. The 'Auto COG' option will automatically steer the desired course to your destination. Your speed and course can also be selected from the Navigation Page using the rocker keypad (see page 13).

SECTION 2

POSITION PAGE

Overview



The trip odometer can be reset from the Position Page options window. To reset the odometer, select the "Reset Trip Distance" option and press EDIT/ENTER.

Position Page

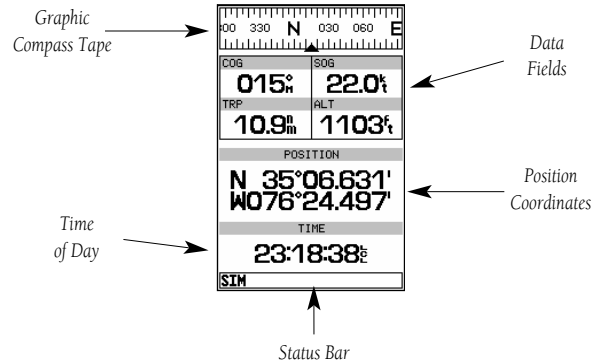

The GPSMAP 230 Position Page shows you where you are, what direction you are heading and how fast you are going. The top of the page features a graphic compass tape to indicate the direction you're heading (while you're moving), and four user selectable data fields: course over ground (COG), speed over ground (SOG), distance traveled (TRP) and altitude (ALT). The bottom half of the page displays your present position's coordinates, along with the time of day as calculated using GPS satellites. The status bar at the bottom of the page indicates position fix status, and is described in detail on page 18.

The units of measure for speed, distance, position, and altitude are all user-selectable through the navigation setup option on the Main Menu Page. The time of day, shown in UTC (Universal Time Coordinated, or Greenwich Mean Time) may be set to display in a 12- or 24-hour time format (with a local offset) through the system setup option on the Main Menu Page.

Position Page Options

The GPSMAP 230's Position Page features a context-sensitive options page that provides access to functions and features relating to the Position Page.

To display the Position Page options:

1. Press **MENU**.

To select a menu option:

1. Highlight the desired option and press **EDIT/ENTER**.

The following options are available:

- **Reset Trip Distance?**— resets the trip odometer (TRP) field to zero.
- **Change Data Fields?**— allows you to choose the data displayed in the four user-selectable data fields. Five data types are available:
 - SOG— speed over ground
 - COG— course over ground
 - TRP— distance traveled
 - ALT— altitude
 - VDC— DC voltage

To change a data field:

1. Highlight the 'Change Data Fields?' option and press **EDIT/ENTER**.
2. Move the field highlight to the field you want to change and press **EDIT/ENTER**.
3. Select the desired data field option and press **EDIT/ENTER**.

- **Restore Defaults?**— resets all data fields to the factory settings.
- **Setup Simulator?**— allows you to define speed, course and position values while in simulator mode. See the Getting-Started Tour for more on using simulator mode.

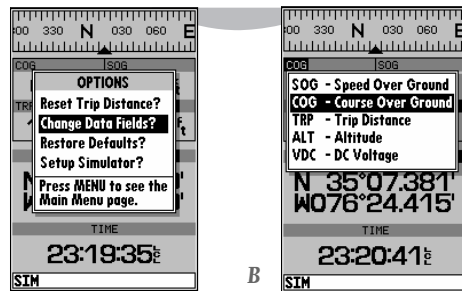

- A. The four data fields at the top of the position page can be changed by selecting the 'Change Data Fields?' option.
- B. Each data field can be set to display speed over ground, course over ground, distance traveled, altitude, or DC voltage.

SECTION

3

MAP PAGE

Overview

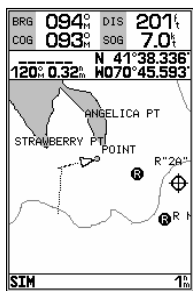

A

B

- A.** Use the cursor to pan ahead to other map areas. The map display will automatically scroll forward when you reach the edge of the map.
- B.** To select or “highlight” an on-screen navaid or waypoint, simply move the cursor over the waypoint symbol. The cursor will “snap” to the waypoint, and display its name and position in the data field.

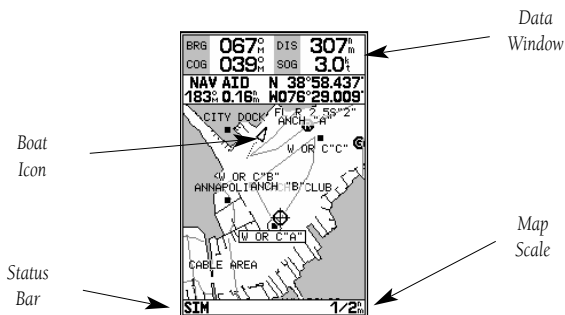
GPSMAP 230 Map Page

The GPSMAP 230's Map Page provides a comprehensive display of electronic cartography, plotting and navigational data. The **map display** shows your boat on a digital chart, complete with geographic names, navaids, depth contours and a host of other chart features. It also plots your track and displays any routes and waypoints you create. An on-screen cursor lets you pan and scroll to other map areas, determine the distance and bearing to a position, and perform various route and waypoint functions.

The **data window**, located at the top of the page, provides a user-selectable display of your current course and speed over ground, along with the bearing and distance to a destination waypoint. Whenever the cursor is active, an additional data window will appear below to indicate the position, range and bearing to the cursor or a selected waypoint or navaid. Each data field may be configured to display any one of ten data options. The data window may also be changed to display additional data fields, a graphic compass tape, or a CDI scale. The **status bar** at the bottom of the page displays the map scale currently in use.

Map Modes

The map display uses the cursor keypad and a set of hard keys to control most map display functions. The **IN** and **OUT** keys, combined with the  keypad, let you select zoom ranges and move the cursor. Two basic map operating modes, position mode and cursor mode, determine what cartography is shown on the map display. Position mode pans the cartography to keep the present position marker within the display area, while cursor mode pans the cartography to keep the cursor within the display area.

The GPSMAP system will always power up in the position mode, with your vessel centered on the map display.

- Whenever sufficient map coverage is not available to keep the boat centered, the boat icon will move toward the edge of the display.
- If the boat icon attempts to go off the display, the zoom level may need to be adjusted to keep cartography on screen.

Whenever the  keypad is pressed, the GPSMAP 230 will enter cursor mode. In cursor mode:

- The cursor can be moved over the map display using the  keypad.
- Whenever the cursor reaches the edge of the display, the map will scroll forward under the cursor. Keep in mind that the boat icon will move with the map scrolling and may go off the display screen (you may not be able to see your present position).
- When the cursor is stationary, a fixed coordinate position will appear in the position field. Note that the distance and bearing will change as the boat's position changes.
- Whenever you zoom in cursor mode, the cursor will be centered on screen.
- To return to position mode, press the **QUIT** key.

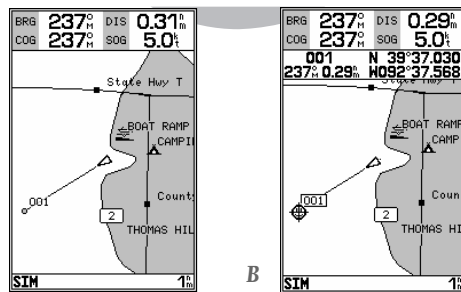

A. Position mode on inland water cartography.

B. Cursor mode on inland water cartography.

SECTION

3

MAP PAGE

Using the Cursor

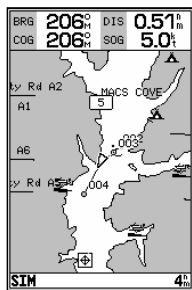

A

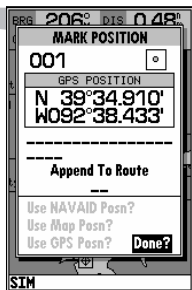

B

A. To create a new waypoint at the cursor, move the cursor to the desired position and press EDIT/ENTER.

B. The create new waypoint page will appear, where you may change the waypoint name, symbol, and comment before saving the waypoint.

Using the Cursor

The cursor allows you to pan away from your present position and scroll to other map areas around the world (even outside of your current G-chart™ coverage). As you pan past the edge of the current map display, the screen will actively scroll forward to provide continuous map coverage.

To move the cursor:

1. Press the keypad to move the cursor in an up, down, left, or right direction.

As you move the cursor, the distance and bearing from your present position to the cursor will be displayed in the data window, along with the cursor's position coordinates. Keep in mind that when the cursor is stationary, the distance and bearing from your present position will change as your boat moves. The cursor may also be used to “snap” to on-screen waypoints and nav aids, allowing you to review a selected position directly from the map display.

To select an on-screen waypoint or nav aid with the cursor:

1. Use the keypad to move the cursor to the desired waypoint or nav aid (if there are several waypoints grouped closely together, zoom in closer for a better view).
2. When a waypoint or nav aid is selected, it will become highlighted on screen, with the name and position displayed.

To eliminate the cursor and re-center your position on-screen:

1. Press the key.

The cursor may also be used to create new waypoints directly from the map.

To create a waypoint with the cursor:

1. Use the keypad to move the cursor to the desired map position.
2. Press .
3. Press to confirm the new waypoint.

Selecting Map Scales

The map display has 16 available range scales from 1/8th to 4096 n.m. (1/4 to 7500km). The map scale is controlled by the **IN** and **OUT** keys, with the current scale displayed at the bottom of the data window.

To select a map scale:

1. Press the up **OUT** key to zoom out and the down **IN** key to zoom in.

The GPSMAP 230's system has a built-in worldwide database to 64 n.m.(see Appendix D for a built-in coverage map), with more detailed coverage available through the use of G-chart™ data cartridges (see Section 10 for installing and using G-chart™ cartridges). The GPSMAP 230 will display cartography as long as there is chart information available for the range you've selected. Map coverage will conform to the following conditions:

- When the selected zoom range is covered by either the internal database or a G-chart data cartridge, cartography will be displayed.
- When the selected zoom range is covered by both the internal database and a G-chart cartridge, cartography will be displayed using the data with the best resolution.
- When the selected zoom range exceeds the resolution of the chart in use by up to two settings, overzoom cartography will be displayed. The display will not show any filled landmass areas, and an 'Ovr Zm' warning will appear in the scale field. The lat/lon grid will also be turned on regardless of the map configuration setting.
- When the selected zoom range exceeds the resolution of the chart in use by more than two settings, all cartography will be replaced by a track plot display, and a 'No Map' warning will appear in the scale field. The lat/lon grid will be displayed regardless of the map configuration setting. Additional caution should be used while navigating in track plot mode.

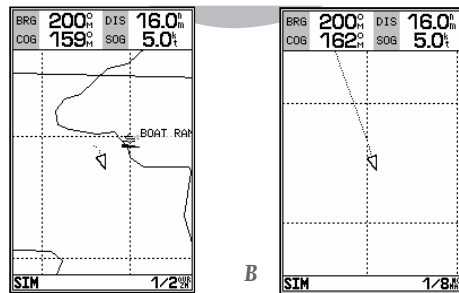

- A. Whenever the selected map scale exceeds the resolution of the chart by up to two settings, an 'Ovr Zm' warning will appear in the scale field.
- B. Whenever the selected map scale exceeds the resolution of the chart by more than two settings, a 'No Map' warning will appear in the scale field.

SECTION

3

MAP PAGE

Map Page Options

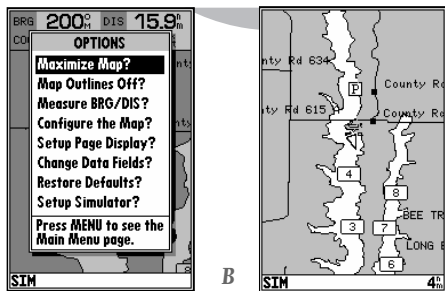

A. The map options page provides access to all map configuration, page display, and data field options.

B. The 'Maximize Map?' option will eliminate the data fields and show full-screen cartography.

Map Page Options

The GPSMAP 230 Map Page is designed to be a flexible tool that can be custom-tailored to your exact navigation needs. The map options page provides access to many of the features and functions that will help you configure the Map Page to your own preferences.

To display the Map Page options:

1. Press **MENU**.

To select a menu option:

1. Highlight the desired option and press **EDIT/ENTER**.

The following options are available:

- **Maximize/Normal Map?**— allows you to select between a full-screen map display or the default map display with data window.
- **Map Outlines Off/On?**— allows you to specify whether coverage outlines for G-chart cartography are displayed or not. The default setting is on.
- **Measure BRG/DIS?**— allows you to measure the bearing and distance between any two points on the map display.

To measure the BRG/DIS between two points:

1. Highlight the 'Measure BRG/DIS?' option and press **EDIT/ENTER**. An on-screen pointer will appear on the map display at your present position.
2. Move the cursor to the desired reference point (the point that you want to measure from) and press **EDIT/ENTER**.
3. Move the cursor to the point that you want to measure to. The bearing and distance from the reference point will be displayed at the bottom left of the data window.
4. Press the **QUIT** key to finish.

SECTION
3

MAP PAGE
Map Configuration

• **Configure the Map?**— allows you to determine what chart features are displayed on a particular map scale to prevent excessive clutter. The map configuration page features an on/off grid with a list of chart features down the left side. The zoom scales are displayed across the top of the grid with the chart scale currently in use also indicated. The far-left scale setting represents all map scales 64 nm and above. A check mark in a grid box indicates that the chart feature listed will be displayed at the corresponding scale.

Individual grid boxes may be turned on and off through a popup scale window, while entire rows may be controlled by using the map configuration options page (accessible through the **MENU** key).

To use the map configuration grid:

1. Use the **⬇** keypad to select the desired map item and press **EDIT/ENTER**.
A popup window will appear with the current settings displayed.
2. Use the **⬆** keypad to highlight the scale you want to change.
3. Press **EDIT/ENTER** to change the on/off setting.
4. Press **QUIT** to finish.

To turn an entire row on or off:

1. Use the **⬇** keypad to select the desired map item.
2. Press the **MENU** key.
3. Select the 'Enable Row?' or 'Disable Row?' option and press **EDIT/ENTER**.

The map configuration page also allows you to set the moving map display to a North Up, Track Up, or Desired Track Up orientation.

To change the map orientation:

1. Use the **⬆** keypad to highlight the 'Orientation' field and press **EDIT/ENTER**.
2. Select the desired setting and press **EDIT/ENTER**.

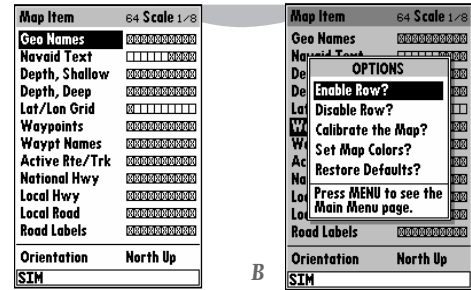

- A. The map configuration grid allows you to define what items appear on the display at each map scale.
- B. To turn an entire row on for the selected map item, highlight the 'Enable Row?' option and press **EDIT/ENTER**.

SECTION

3

MAP PAGE

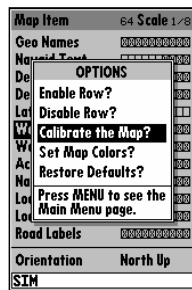
Map Configuration
& Map Colors

A

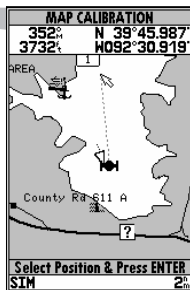

B

A. To calibrate the map, highlight the 'Calibrate the Map?' option and press EDIT/ENTER.

B. A satellite icon will remain on the map to indicate the GPS position, while the boat marker will move to reflect the calibration changes.

CAUTION!

The map calibration function should never be used to attempt corrections to Selective Availability errors.

The map configuration options page also features a map calibration function that allows you to calibrate the map display your exact physical surroundings or to correct data from older charts. Before using the map calibration function, check to make sure that your map datum selected on the GPS matches the datum on the chart you are using (see page 61). To calibrate the map display, you must know exactly where you are, and understand that the correction is generally valid only in a limited range from the point of correction.

Map calibration should only be performed while the vessel is not moving, and should never be used to attempt SA corrections, which can degrade accuracy up to 330' (100 meters). The maximum correction is 16,400 feet (5000m).

To calibrate the map:

1. Select the 'Calibrate the Map?' option and press **EDIT/ENTER**.
2. Use the **▲** keypad to move the arrow cursor from the satellite position (indicated by the satellite icon) to your exact position. The bearing, distance, and position will be indicated in the data window.
3. Press **EDIT/ENTER** to confirm the calibration offset.

The next option available from the map configuration page is the set map colors option, which allows you to define the fill color (grayscale) of the land and water used on the map display. Three options are available: no color (no fills for land or water), gray land/white water (the default setting), and white land/gray water.

To select a map colors option:

1. Select the 'Set Map Colors?' option and press **EDIT/ENTER**.
2. Highlight the desired map color option and press **EDIT/ENTER**.

The map configuration options page also features a 'restore defaults' function that can be used to quickly restore all map configuration options to the factory settings.

To restore the map configuration options to the factory defaults:

1. Highlight the 'Restore Defaults?' settings and press **EDIT/ENTER**.

• **Setup Page Display?**— allows you to specify the number of fields displayed in the data window section of the map page. A graphic compass tape or CDI scale may also be displayed. The following options are available:

- 2 Fields
- 2 Fields & Compass
- 2 Fields & CDI
- 4 Fields
- 4 Fields & Compass
- 4 Fields & CDI
- 6 Fields
- 6 Fields & Compass
- 6 Fields & CDI
- 8 Fields

To select a page display option:

1. Highlight the 'Setup Page Display?' option and press **EDIT ENTER**.
2. Select the desired option and press **EDIT ENTER**.

• **Change Data Fields?**— allows you to specify the data displayed in each data field used on the map display. The following options are available:

- BRG- bearing to active wpt
- DIS- distance to active wpt
- SOG- speed over ground
- COG- course over ground
- ETE- estimated time enroute
- ETA- estimated time of arrival
- XTK- crosstrack error
- VMG- velocity made good
- TRN- turn angle to wpt
- WPT- active wpt name

To change a data field:

1. Highlight the 'Change Data Fields?' option and press **EDIT ENTER**.
2. Move the field highlight to the desired field and press **EDIT ENTER**.
3. Select a data field option and press **EDIT ENTER**.

• **Restore Defaults?**— resets all map page options (except map configuration options, see pages 27-28) to the factory settings.

• **Setup Simulator?**— allows you to define speed, course, and position values while in simulator mode. See the Getting-Started Tour for more on using simulator mode.

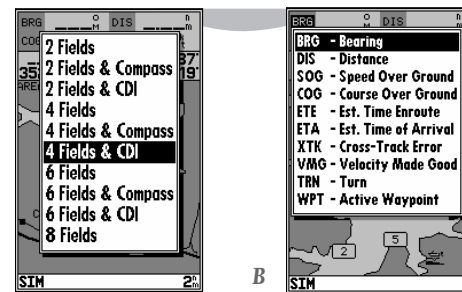

A. The map page can be configured to display a variety of navigation data.

B. Each data field can be set to display one of ten data options.

SECTION 4 NAVIGATION PAGE

Overview

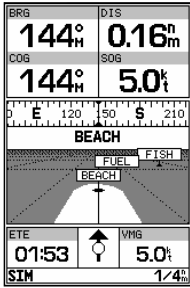

The Navigation Page can be configured to show the active waypoint, all route waypoints and/or nearby waypoints on the graphic highway.

GPSMAP 230 Navigation Page

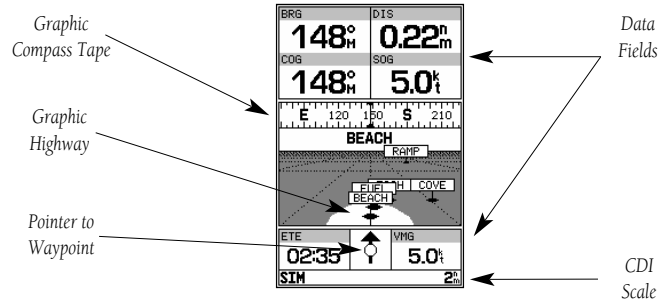

Whenever a GOTO, MOB, TracBack or route has been activated, the GPSMAP 230 will provide digital and graphic steering guidance to the destination with the Navigation Page. The top half of the nav page features four user-selectable **data fields** that display the bearing (BRG) and distance (DIS) to waypoint, along with your current course (COG) and speed over ground (SOG). In addition, there's a moving compass tape to indicate the direction you're heading. Two additional data fields at the bottom of the page show the estimated time enroute (ETE) and velocity made good (VMG) to your destination.

The middle section of the screen provides visual guidance to the waypoint on a **graphic highway** display. The line down the center of the highway represents your desired track, while a graphic indication of the distance and direction you are off course is shown on a scale at the bottom right of the page (the selected scale represents the distance from side to side). The **arrow pointer** below the highway always points to the destination waypoint relative to the direction you are moving.

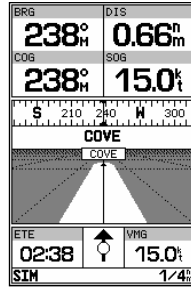
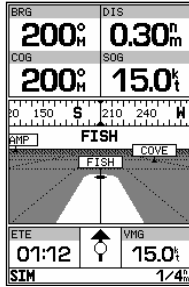

NAVIGATION PAGE SECTION 4

Highway Scale & Nav Page Options

As you head toward your destination, the highway will move to indicate your progress to the waypoint and which direction you should steer to stay on course. If you are navigating a route, the Navigation Page will show each route waypoint in sequence, with the active leg indicated by the white portion of the highway. Nearby waypoints not in the active route will also be displayed. The highway scale may also be zoomed in or out to display a larger or smaller view of the highway. Five scales are available from 1/4 to 4 nm, with a default setting of 1/4 nm.

To change the highway scale:

1. Press the **IN** or **OUT** key to select the desired setting.

Navigation Page Options

The GPSMAP 230's navigation options page allows you to define the nav data fields and select what waypoints are displayed on screen.

To display the Navigation Page options:

1. Press **MENU**.

To select a menu option:

1. Highlight the desired option and press **EDIT/ENTER**.

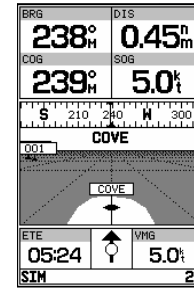

A



B

- To change the highway scale, press the **IN** and **OUT** keys.
- The navigation options page lets you set up the Navigation Page to your own preferences.

SECTION 4 NAVIGATION PAGE

Nav Page Options

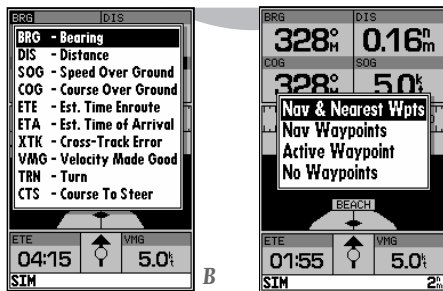

A. Ten data options are available for each data field on the Navigation Page. The digital crosstrack error option is especially useful to display the exact distance you are off course in feet/miles or meters.

B. To select what waypoints appear on the graphic highway, highlight the desired setting and press EDIT/ENTER.

The following options are available for the Navigation Page:

- **Change Data Fields?**— allows you to define the data displayed in any of the six user-selectable data fields. Ten data options are available:
 - BRG— bearing to active wpt
 - DIS— distance to active wpt
 - SOG— speed over ground
 - COG— course over ground
 - ETE— estimated time enroute
 - ETA— estimated time of arrival
 - XTK— crosstrack error
 - VMG— velocity made good
 - TRN— turn angle to wpt
 - CTS— course to steer

To change a data field:

1. Highlight the 'Change Data Fields?' option and press **EDIT/ENTER**.
2. Highlight the field you want to change and press **EDIT/ENTER**.
3. Select the desired data field option and press **EDIT/ENTER**.

• **Configure Highway?**— allows you to select what waypoints are shown on the highway display. Four options are available:

- Nav & Nearest Waypoints— all route and nearest waypoints displayed
- Nav Waypoints— only waypoints in the active route will be displayed
- Active Waypoint— only the active waypoint will be displayed
- No Waypoints— no waypoints will be displayed

To configure the highway display:

1. Highlight the 'Configure Highway?' option and press **EDIT/ENTER**.
2. Select the desired option and press **EDIT/ENTER**.

• **Restore Defaults?**— resets all navigation page options to the factory settings.

• **Setup Simulator?**— allows you to define speed, course, and position values while in simulator mode. See pages 4-16 for more details on using simulator mode.

• **Auto COG?**— allows you to reset automatic steering while simulating navigation and cancel any course adjustments made with the **⏏** keypad.

Main Menu Page

The GPSMAP 230's Main Menu Page provides access to various waypoint, system, navigation, and interface management and setup menus. The Main Menu Page is available from any page in the GPSMAP 230's system, and is accessed through the **MENU** key.

MAIN MENU
Nearest Waypoints
Proximity Waypoints
Create Waypoint
Waypoints
Routes
Track
Trip & Fuel Planning
System Setup
Navigation Setup
Timers & Alarms
Input/Output
SIM

To access the Main Menu Page:

1. Press **MENU** twice.

The 11 submenus are divided into categories by function.

To select a submenu from the Main Menu Page:

1. Highlight the submenu you want to view and press **EDIT/ENTER**.

For specific instructions on using a submenu, see the waypoints, route, or setup sections of this manual.

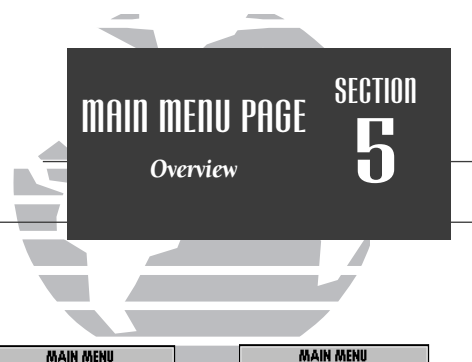

A

MAIN MENU
Nearest Waypoints
Proximity Waypoints
Create Waypoint
Waypoints
Routes
Track
Trip & Fuel Planning
System Setup
Navigation Setup
Timers & Alarms
Input/Output
SIM

B

MAIN MENU
Nearest Waypoints
Proximity Waypoints
Create Waypoint
Waypoints
Routes
Track
Trip & Fuel Planning
System Setup
Navigation Setup
Timers & Alarms
Input/Output
SIM

- A. The waypoint category options on the Menu Page are described in the 'Waypoints' section on pages 34-42.
- B. The routes category options are described on pages 47-54.

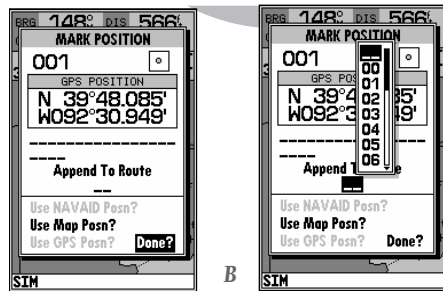

A. The MARK key is used primarily to mark your present position, but it can also be used to mark the cursor or a navaid position from the map page.

B. The mark position page also allows you to add the new waypoint to the end of any route. If you're heading out without a planned route, you can create a series of waypoints along the way with the mark key and save them to an open storage route. When you're ready to head back, simply invert the route to get back (see page 51).

Creating and Using Waypoints

The GARMIN GPSMAP 230 stores up to 250 alphanumeric waypoints with a user-defined icon and comment available for each waypoint. Waypoints can be created using three basic methods:

- **MARK key**— used primarily for marking your present position, the **MARK** key also provides options that allow you to select a map or navaid position from the map display.
- **On Map**— allows you to define a new waypoint position from the map display using the cursor.
- **Text Entry**— allows you to enter a new waypoint's position coordinates manually (from a chart, etc.) or by referencing it's bearing and distance from a stored waypoint or your present position.

Mark Key

The GARMIN GPSMAP 230's **MARK** key lets you quickly capture your present position— or cursor or navaid position— in order to create a new waypoint. You must have a valid position fix to mark your present position.

To mark your present position:

1. Press the **MARK** key. The mark position page will appear, with a default three-digit name for the new waypoint.
2. To accept the waypoint with the default name, symbol and comment (the date and time of creation), press **EDIT/ENTER** to confirm the 'Done?' prompt.
3. To enter a different name, symbol or comment, highlight the appropriate field and press the **EDIT/ENTER** key.
4. After entering and confirming your changes, move the field highlight back to the 'Done?' prompt and press **EDIT/ENTER**.



The MARK key may also be used on the Map Page to mark the cursor position or an on-screen navaid. To mark a navaid, select the desired navaid with the cursor. The GPSMAP 230 will use the navaid text shown on the cartography as the default comment.

To mark the cursor or navaid position with the **MARK** key:

1. Use the **⬇** keypad to move the cursor to the desired position or navaid.
2. Press the **MARK** key.
3. Highlight the 'Use Map Posn?' or the 'Use NAVAID Posn?' option and press **EDIT/ENTER**.
4. To accept the waypoint with the default name, symbol, and comment (the date and time of creation), press **EDIT/ENTER** to confirm the 'Done?' prompt.
5. To enter a different name, symbol or comment, highlight the appropriate field and press the **EDIT/ENTER** key.
6. After entering and confirming your changes, move the field highlight back to the 'Done?' prompt and press **EDIT/ENTER**.

WAYPOINTS

SECTION

6

Using the MARK Key

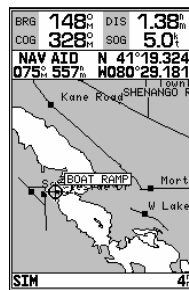

A

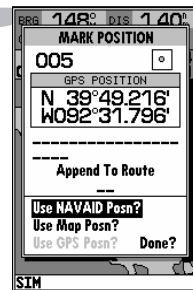

B

- A. To create a waypoint at an on-screen navaid, move the cursor over the desired navaid.
- B. Press the MARK key and select the 'Use Navaid Posn?' option. Press EDIT/ENTER to finish.

SECTION

6

WAYPOINTS

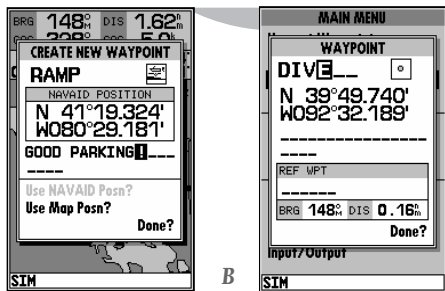
Creating Waypoints On
Map & By Text

A

B

A. Once a position has been selected on map, the create new waypoint page will appear. Here you can change the waypoint name, symbol or comment before saving the waypoint.

B. To create a waypoint by text entry, start by entering the new waypoint's name.

Creating Waypoints On Map

Waypoints may also be quickly created from the map display, which allows you to “point and shoot” at any map position to create a new waypoint.

To create a new waypoint on map:

1. Use the keypad to move the cursor to the desired map position. If you want to create the new waypoint at an on-screen navaid, highlight the navaid on the map display.
2. Press .
3. To accept the waypoint with the default name, symbol and comment, press . If you are creating a waypoint at an on-screen navaid, the default symbol and comment will automatically reflect the selected navaid's name and symbol.
4. To change the name, symbol or comment, highlight the appropriate field and press .
5. After entering and confirming your changes, move the field highlight back to the 'Done?' prompt and press .

Creating Waypoints By Text Entry

Waypoints may also be created by manually entering a position's coordinates or referencing a stored waypoint through the 'Create Waypoint' submenu option on the Main Menu Page.

To create a new waypoint by manually entering its coordinates:

1. Press twice to display the Main Menu Page.
2. Highlight the 'Create Waypoint' option and press . The waypoint definition page will appear, with the next available waypoint number and the receiver's last known position as the default name and position.
3. Use the keypad to enter the new waypoint name, icon, position, and comment. Press after the last character in each section.
4. When you have finished entering all your waypoint data, use the keypad to highlight the 'Done' prompt and press .

Reference Waypoints

A new waypoint may also be created without knowing position coordinates by entering its range and bearing from an existing waypoint or your present position. The GPSMAP 230 will then calculate the position coordinates for you, using the reference selected.

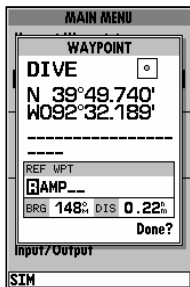

To create a new waypoint using a reference waypoint:

1. Select the 'Create Waypoint' option from the Main Menu Page and press **EDIT/ENTER**.
2. Enter the name, icon, and comment for the new waypoint.
3. Highlight the reference waypoint field and press **EDIT/ENTER**.
4. Enter the name of the reference waypoint using the **NUM** keypad, or press **MENU** to select the waypoint from the nearest list, waypoint list, or map display. Leave the reference field blank to use your present position.
5. Press **EDIT/ENTER** to begin entry of the bearing from your reference waypoint to the new waypoint position. Enter the bearing and press **EDIT/ENTER**.
6. Press **EDIT/ENTER** to begin entry of the distance from your reference waypoint to the new waypoint position. Enter the distance and press **EDIT/ENTER**. The position for the new waypoint will automatically be calculated.
7. Highlight the 'Done' prompt and press **EDIT/ENTER** to finish.

WAYPOINTS

SECTION

Creating a Waypoint by Reference

6

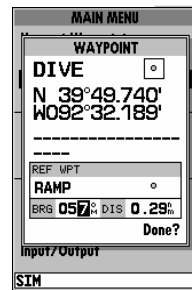

A

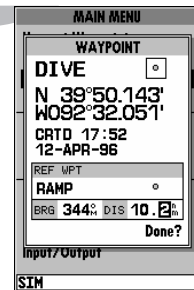

B

- A. Enter the bearing from the reference waypoint to the new waypoint in the 'BRG' field.
- B. Enter the distance from the reference waypoint to the new waypoint in the 'DIS' field.

SECTION

6

WAYPOINTS

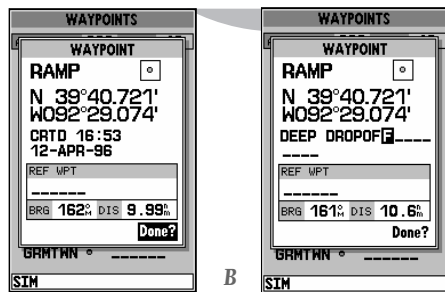
Reviewing &
Editing Waypoints

A. The waypoint definition page will appear whenever a waypoint is selected from the map or a waypoint list.

B. A 20-character custom waypoint comment may be assigned to every waypoint. The default comment is the date and time of creation.

Reviewing & Editing Waypoints By Text

Once you have created and stored a waypoint, it may be modified, reviewed, renamed, or deleted at any time through the waypoint definition page. The waypoint definition page is available for any stored waypoint by highlighting the desired waypoint from the map display or selecting it from any waypoint list and pressing the **EDIT ENTER** key.

To access the waypoint definition page:

1. Use the **ENTER** keypad to highlight the desired waypoint on the map display (or any waypoint list).
2. Press **EDIT ENTER** to display the waypoint definition page.

From the waypoint definition page, you may change the waypoint symbol, position coordinates, or the waypoint comment for the selected waypoint.

To change the waypoint symbol:

1. Highlight the waypoint symbol field and press **EDIT ENTER**.
2. Use the **ENTER** keypad to select the desired symbol and press **EDIT ENTER** to confirm.

To change the position coordinates:

1. Highlight the coordinates field and press **EDIT ENTER**.
2. Use the **ENTER** keypad to edit the coordinates and press **EDIT ENTER** to confirm.

To change the waypoint comment:

1. Highlight the comment field and press **EDIT ENTER**.
2. Use the LEFT arrow of the **ENTER** keypad to clear the comment field.
3. Use the **ENTER** keypad to enter a comment (up to 16 characters).
4. Press **EDIT ENTER** to confirm.

Waypoint Definition Page Options

The waypoint definition page also features an options page that allows you to edit the selected waypoint on the map display, rename the selected waypoint or delete the waypoint from memory.

To display the waypoint definition page options:

1. Press the **MENU** key.

To review/edit the selected waypoint from the map display:

1. Highlight the 'Edit Wpt On Map?' option and press **EDIT/ENTER**.
2. The selected waypoint will appear on the map display, with the waypoint name and coordinates shown at the top of the map, along with the distance and bearing to the waypoint from your present position.
3. To move the selected waypoint's position, press **EDIT/ENTER**. A 'MOVE' label will now appear under the cursor arrow.
4. Use the **⬇** keypad to move the cursor arrow to the desired position. The cursor's coordinates, along with the distance and bearing from the waypoint's position, will be displayed at the top of the map display.
5. Press **EDIT/ENTER** to set the waypoint's new position, and **QUIT** to return to the waypoint definition page.

To rename the selected waypoint:

1. Highlight the 'Rename Waypoint?' option and press **EDIT/ENTER**.
2. Enter the new waypoint name and press **EDIT/ENTER**.
3. Press **EDIT/ENTER** to confirm the 'Yes' prompt.

To delete the selected waypoint:

1. Highlight the 'Delete Waypoint?' option and press **EDIT/ENTER**.
2. Press **EDIT/ENTER** to confirm.

WAYPOINTS

SECTION

Waypoint Definition Page Options

6

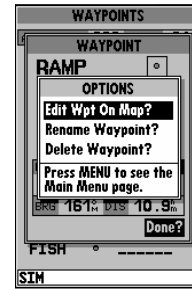

A

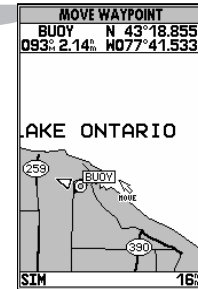

B

- A. To review or edit a waypoint on the map display, select the 'Edit Wpt On Map?' option.
- B. To move the selected waypoint, press **EDIT/ENTER**. Use the arrow keypad to select the new position, and press **EDIT/ENTER** to finish.

SECTION

6

WAYPOINTS

Waypoint Submenus &
Nearest Waypoints

A

MAIN MENU
Nearest Waypoints
Proximity Waypoints
Create Waypoint
Waypoints
Routes
Track
Trip & Fuel Planning
System Setup
Navigation Setup
Timers & Alarms
Input/Output
SIM

B

NEAREST WAYPOINTS			
WAYPOINT	BRG	DIS	
001	193°	0.24mi	
002	191°	2.25mi	
003	192°	2.29mi	
004	197°	2.94mi	
RAMP	060°	7.39mi	
COVE	023°	10.7mi	
FISH	025°	11.3mi	
FUEL	024°	11.7mi	
BEACH	024°	11.9mi	
SIM			

A. The Menu Page features four waypoint submenus.

B. The nearest waypoint list continuously updates to show the nine nearest waypoints to your present position.

Waypoint Submenus

The GPSMAP 230's Main Menu Page features four waypoint submenus that let you manage a large number of waypoints quickly and efficiently. The submenus also provide a continuously updated nearest waypoints list and a proximity waypoint alarm function that can be used to define an alarm circle around submerged hazards, shallow waters, etc.

To access the Main Menu Page waypoint submenus:

1. Press **MENU** twice.

The first waypoint submenu is the **nearest waypoints list**, which shows the nine nearest waypoints that are within 100 miles of your present position. The nearest waypoints are continuously updated to your present position, and provide quick access to the closest points of safety in emergency situations.

To scroll through and review the nearest waypoint list:

1. Highlight the 'Nearest Waypoints' option and press **EDIT/ENTER**.
2. Use the **▲** keypad to scroll through the list in either direction.
3. Press **EDIT/ENTER** to review the highlighted waypoint.
4. To return to the waypoint list, highlight the 'Done?' prompt and press **EDIT/ENTER**.
5. The field highlight will automatically scroll to the next waypoint. If you want to review each waypoint, you can scroll through any waypoint list by pressing the **EDIT/ENTER** key repeatedly.

To select a nearest waypoint as a GOTO destination:

1. Use the **▲** key to select the desired GOTO waypoint.
2. Press **GOTO**, followed by **EDIT/ENTER**.

SECTION

6

WAYPOINTS

Create Waypoint &
Waypoint List

A

WAYPOINTS	
AVAILABLE	USED
003	PARK
005	T001
006	T002
007	T003
008	T004
009	-----
DIVE-5	-----
FISH-3	-----
GROUPR	-----
KEYHST	-----
MARINA	-----
NASSAU	-----
SIM	

B

WAYPOINTS	
AVAILABLE	USED
001	GARMIN
002	RAMP
OPTIONS	
Delete Waypoint?	
Delete All User Wpts?	
Press MENU to see the Main Menu page.	
COVE	-----
DIVE	-----
FISH	-----
FUEL	-----
SIM	

A. The waypoints list displays all waypoints stored in memory in a two-column format. Temporary waypoints created by the TracBack feature are assigned a 'TXXX' name and a footprint symbol.

B. The waypoints list options page lets you delete individual waypoints or the entire waypoint list.

Create Waypoint

The third waypoint submenu available from the Main Menu Page is the 'Create Waypoint' submenu, which allows you to create a new waypoint by manually entering coordinates. Instructions for using the create waypoint submenu are provided on page 36.

Waypoint List

The last waypoint category available from the Main Menu Page is the **waypoints list**, which displays a master list of all waypoints currently stored in memory. From the waypoints list, you may review, edit, rename, or delete individual waypoints; or delete all user waypoints. The total number of stored and available waypoints is displayed at the top of the waypoints page, with the stored waypoints arranged in numerical/alphabetical order and listed in two columns in the center of the page.

To scroll through and review the waypoint list:

1. Highlight the 'Waypoints' option from the Main Menu Page and press **EDIT/ENTER**.
2. Use the **▲** keypad to scroll through the list in the desired direction.
3. Press **EDIT/ENTER** to review the highlighted waypoint.
4. Press **EDIT/ENTER** to return to the list.

To delete an individual waypoint from the list:

1. Use the **▲** keypad to highlight the waypoint to be deleted and press **MENU**.
2. Press **EDIT/ENTER**.
3. Press the **EDIT/ENTER** key to confirm the deletion warning.

To delete the entire waypoint list:

1. Press the **MENU** key to select the options window.
2. Highlight the 'Delete All User Wpts?' option and press **EDIT/ENTER**.
3. Use the **▲** keypad to highlight the 'YES' prompt and press **EDIT/ENTER** to confirm.

Going to a Destination

The GPSMAP 230 provides four ways to navigate to a destination: **GOTO**, **MOB**, **TracBack** and **route navigation**. The most basic method of selecting a destination is the GOTO function, which lets you select a waypoint as your destination and quickly sets a direct course from your present position. The **GOTO** key can be used in three ways: from a list of waypoints, directly from the map display and from a list of GOTO options. Pressing the **GOTO** key once displays a list of all waypoints in memory, from which you can select a single destination waypoint.

To activate a GOTO from the waypoint list:

1. Press the **GOTO** key.
2. Select a waypoint and press **EDIT/ENTER**.

Selecting a GOTO On Map

Pressing the **GOTO** key twice allows you to graphically select an on-screen waypoint, navaid, or cursor position as a destination. A graphical GOTO may be used to select one of three options from the map display: an existing waypoint, an on-screen navaid, or a cursor position. If you are selecting a navaid or a new position as the GOTO destination, the GPSMAP 230 will automatically create or move the waypoint named 'MAP' at the navaid or map position.

To activate a GOTO from the map display:

1. Press the **GOTO** key twice.
2. To select an existing user waypoint, highlight the waypoint on screen and press **EDIT/ENTER**.
3. To select a navaid, highlight the navaid on screen and press **EDIT/ENTER**. The 'GOTO NEW WAYPOINT' page will appear, displaying the navaid position as a 'MAP' waypoint, with the navaid symbol and text as the default icon and waypoint comment. Press **EDIT/ENTER** to save the waypoint and begin navigation.
4. To select a cursor position as your destination, move the arrow cursor to the desired position and press **EDIT/ENTER**. The 'GOTO NEW WAYPOINT' page will appear and display the position as the 'MAP' waypoint. Press **EDIT/ENTER** to save the waypoint and begin navigation.

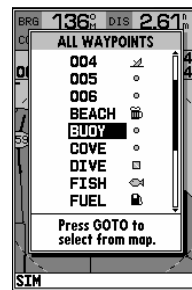
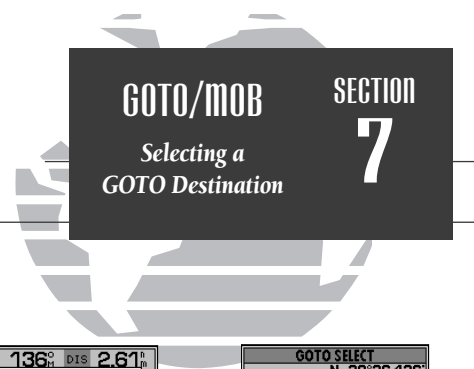

A

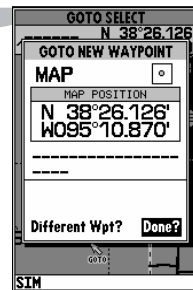

B

- A. Press GOTO once to select a destination from a list of waypoints.
- B. Press GOTO twice to select a destination waypoint with the map cursor. If you are not selecting an existing waypoint as your destination, a new waypoint named 'MAP' will be created. Keep in mind that the MAP waypoint will be overwritten for each MAP GOTO. This allows you to navigate to on-screen nav aids without permanently storing the navaid as a waypoint. If you want to save the MAP waypoint, rename it following the steps on page 39.

SECTION

7

GOTO/MOB

GOTO Options

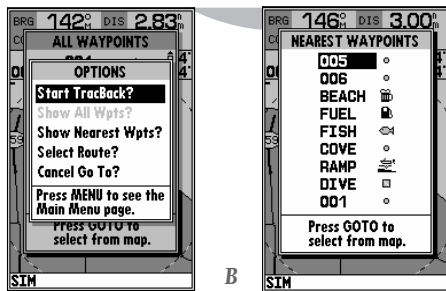

A. The GOTO options page lets you start a TracBack route, select a destination from the nearest list, select a route to activate, or cancel the current GOTO destination.

B. The nearest waypoints list limits waypoint choices to provide quick access to nearby anchorages, facilities, etc. which are stored as waypoints.

GOTO Key Options

The GOTO options page provides a list of additional GOTO options that let you start a TracBack route, select a destination waypoint from the nearest waypoints list, select a route to navigate, or cancel the current GOTO destination.

To display the GOTO options:

1. Press **MENU**.

To select a menu option:

1. Highlight the desired option and press **EDIT ENTER**.

The following options are available:

- **Start TracBack?**— allows you to create and start navigation of a TracBack route back to the oldest track log point in memory (see pages 45-46 for more on using the TracBack function).
- **Show All Wpts?**— displays the GOTO waypoint list.
- **Show Nearest Waypoints?**— allows you to select the GOTO destination from a list of the nine nearest waypoints to your present position.

To select a nearest waypoint as a GOTO destination:

1. Highlight the 'Show Nearest Waypoints' option and press **EDIT ENTER**.
 2. Select the desired waypoint and press **EDIT ENTER**.
- **Select Route?**— allows you to quickly select a stored route for navigation.

To select a route to navigate:

1. Highlight the 'Select Route' option and press **EDIT ENTER**.
 2. Select the desired route and press **EDIT ENTER**.
- **Cancel GOTO?**— cancels the current GOTO destination and resumes navigation of any previously selected route.

MOB

The GPSMAP 230's **man overboard function** (MOB) lets you simultaneously mark and set a course to a position for quick response to emergency situations.

To activate the MOB function:

1. Press the **MOB** key.
2. Press the **EDIT/ENTER** key to confirm and begin navigating to the MOB position.

Once a MOB has been activated, a MOB icon will appear on the map display, and the destination field on the Map Page will display the bearing, distance, and ETE to the MOB position based on your present speed and course.

To stop navigation to the MOB position:

1. Press the **GOTO** key, followed by **MENU**, to display the GOTO options page.
2. Select the 'Cancel GOTO' option and press **EDIT/ENTER**.

TracBack Navigation

The third method of navigating to a destination is by using the GPSMAP 230's **TracBack** feature. The TracBack function allows you to retrace your path using the track log automatically stored in the receiver's memory, which will eliminate the need to store waypoints along the way. TracBack routes are created by reducing your track log into a route of up to 30 waypoints and activating an inverted route along those points. Once activated, a TracBack route will lead you back to the oldest track log point stored in memory, so it's good idea to clear the existing track log at the start of your current trip (e.g., your dock) before you get started.

To clear the track log and define a starting point for a TracBack route:

1. Press the **MENU** key twice to display the Main Menu Page.
2. Highlight the 'Track' option and press **EDIT/ENTER**.
3. Select the 'Delete Track?' option and press **EDIT/ENTER**.
4. Highlight the 'Yes' field and press **EDIT/ENTER**.

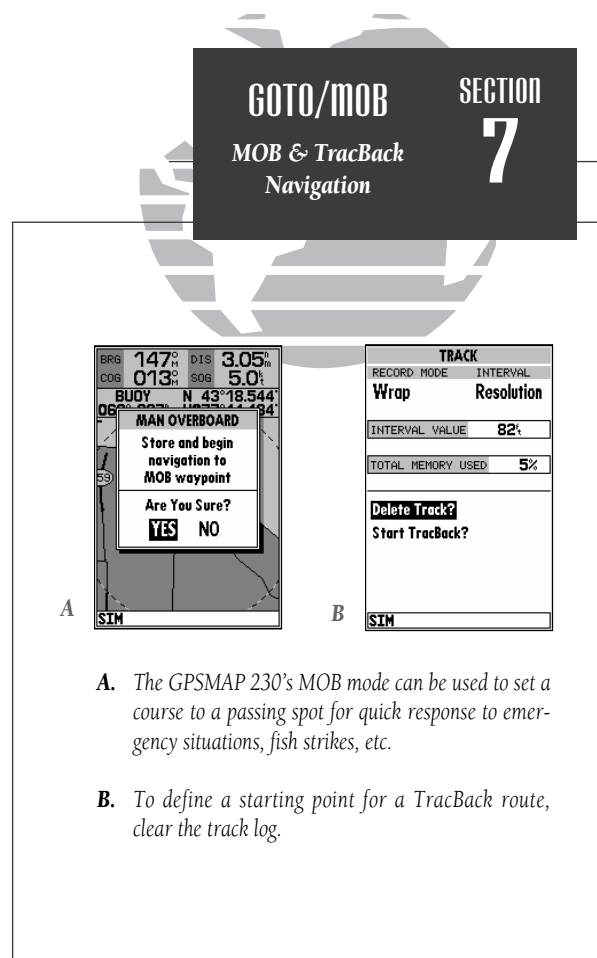

- A. The GPSMAP 230's MOB mode can be used to set a course to a passing spot for quick response to emergency situations, fish strikes, etc.
- B. To define a starting point for a TracBack route, clear the track log.

SECTION

7

GOTO/MOB

TracBack Navigation

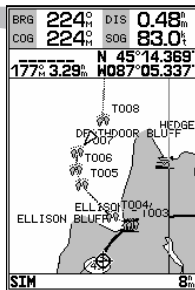
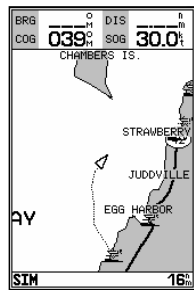

A. The TracBack feature uses your track log to create a route back to where you started.

B. Once a TracBack is activated, the track log is divided into segments using temporary waypoints, and an inverted route is activated back to the oldest track log point in memory.

To activate a TracBack route:

1. Press the **GOTO** key, followed by the **MENU** key.
2. Highlight the 'Start TracBack?' option and press **EDIT/ENTER**.

Once a TracBack has been activated, the GPSMAP 230 will take the track log currently stored in memory and divide it into segments called “legs”. Up to 30 temporary waypoints (e.g. T001) will be created to mark the most significant features of the track log in order to duplicate your exact path as closely as possible. To get the most out of the TracBack feature, remember the following tips:

- Always clear the track log at the point that you want to go back to (dock, etc.).
- The 'RECORD' option on the track log setup page must be set to 'Fill' or 'Wrap'.
- There must be at least two track log points stored in memory to create a TracBack route.
- If there are not enough available waypoints in memory to create a TracBack route, you will be alerted with a 'waypoint memory full' message, and the receiver will use available waypoints to create a route with an emphasis on the track log closest to the destination.
- If the track log interval is set to the 'Time' option, the route may not follow your exact path (keep the interval set to 'resolution' for best performance).
- If the receiver is turned off or satellite coverage is lost during your trip, the TracBack will draw a straight line between any point where coverage was lost and where it resumed.
- If the changes of direction and distance of your track log are very complex, 30 waypoints may not accurately mark your exact path. The receiver will then assign the 30 waypoints to the most significant points of your track, and simplify segments with fewer changes in direction.
- Whenever a TracBack route is activated, the receiver will automatically erase any temporary waypoints (e.g., 'T001') that are not contained in routes 1-20. If there are temporary waypoints stored in routes 1-20, the receiver will create any new temporary waypoints using the first three-digit number available.

Routes

The last way to navigate to a destination is to create a user-defined route. The GARMIN GPSMAP 230 system lets you create and store up to 20 reversible routes (numbered 1-20), with up to 30 waypoints each. Routes can be created and modified right from the Map Page, allowing you to see each route on-screen as you create, review, modify, or navigate the route. All of the GPSMAP 230's route functions are accessed through the main menu.

To create a route on the map:

1. Press the **MENU** key twice to display the Main Menu Page.
2. Highlight the 'Routes' field and press **EDIT/ENTER**. The routes page will appear, showing all the routes currently stored in memory.
3. Press the **MENU** key to display the route options page.
4. Press **EDIT/ENTER** to select the 'Create New Route' option.

The route edit page will appear, with the cursor displayed as an arrow pointer, and will allow you to select your route waypoints using one of two methods:

5. To add an existing waypoint or navaid to the route, use the arrow pointer to highlight the desired waypoint on screen and press **EDIT/ENTER**.
6. To add a new waypoint to the route, use the arrow pointer to select the desired map position and press **EDIT/ENTER**. Press **EDIT/ENTER** again to confirm the new waypoint.

As you add each new waypoint to the route, the **data window** at the top of the map display will show the route number you are creating, along with the first and last route waypoints of the route. A route line will appear on the map to indicate each completed leg, and a dotted line will appear to indicate the distance and bearing to the arrow pointer from the last route waypoint.

7. Repeat steps 5 and 6 until you have finished defining all route waypoints.
8. Press **QUIT** to finish and enter review mode, or **PAGE** to return to the main page sequence.

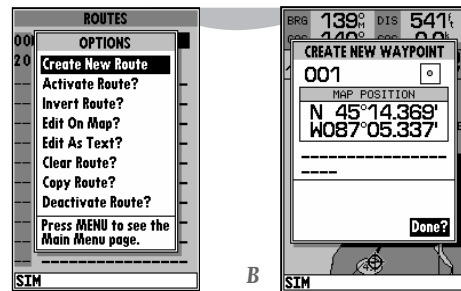
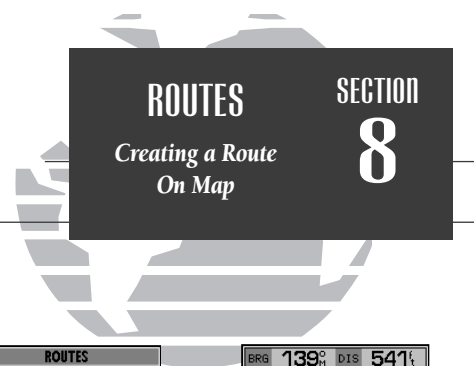

- A. The route options page provides access to the GPSMAP 230's route functions.
- B. Use the arrow pointer and EDIT/ENTER to add waypoints to the route. The create waypoint page will appear whenever you have selected a position that is not already stored as a waypoint.

SECTION

8

ROUTES

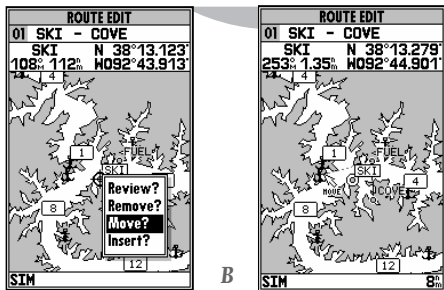
Reviewing & Editing
Routes On Map

A. To move a route waypoint, select the 'Move?' option and press EDIT/ENTER.

B. Move the arrow cursor to the new waypoint position and press EDIT/ENTER to confirm.

Once a route has been created on the map (and the **QUIT** key has been pressed to finish), the map display will automatically enter the route review mode. The arrow pointer will be replaced by the map cursor, located at the last route waypoint. The route edit mode allows you to review and modify the route displayed through a pop-up window menu for each waypoint. You may also use the cursor to select an individual route leg and insert a new route waypoint.

To edit a route waypoint:

1. Use the cursor to highlight the desired route waypoint and press **EDIT/ENTER**.

A pop-up menu of editing choices will appear, with options for reviewing, removing, moving, or inserting a route waypoint.

To review a route waypoint:

1. Highlight the 'Review?' option and press **EDIT/ENTER**.

To remove a route waypoint:

1. Highlight the 'Remove?' option and press **EDIT/ENTER**.

To move a route waypoint:

1. Highlight the 'Move?' option and press **EDIT/ENTER**.
2. Move the cursor to the new map position and press **EDIT/ENTER**.

To insert new route waypoint(s) at the beginning or end of the route:

1. Select the first (to add waypoints to the beginning of the route) or last (to add waypoints to the end of the route) route waypoint with the map cursor, and press **EDIT/ENTER**.
2. Highlight the 'Insert?' option and press **EDIT/ENTER**.
3. Move the cursor to the new waypoint position and press **EDIT/ENTER**.
4. If you are not inserting an existing waypoint, press **EDIT/ENTER** to confirm the new waypoint.
5. Repeat steps 3 and 4 to insert additional waypoints, or press **QUIT** to finish.

The GPSMAP 230's route edit mode also allows you to insert a new route waypoint in any route leg using the map cursor.

To insert a new waypoint between two existing route waypoints:

1. Use the cursor to select the leg you want to insert the new waypoint in (the route line will change to a dotted line when the leg is selected) and press **EDIT/ENTER**.
2. Move the cursor to the new map position and press **EDIT/ENTER**.
3. If you are not inserting an existing waypoint, press **EDIT/ENTER** to confirm the new waypoint.

The route edit options page provides access to a variety of functions which can be used to review, activate, invert, or edit the route as text and adjust the map view of the selected route.

To display the route edit options:

1. Press **MENU**.

To select a menu option:

1. Highlight the desired option and press **EDIT/ENTER**.

The following options are available:

- **Edit As Text?**— allows you to modify a route by text entry.

To edit a route by text entry:

1. Highlight the 'Edit As Text?' option and press **EDIT/ENTER**. The text edit page will appear, showing a list of all route waypoints, with the desired track and distance of each leg displayed.
2. Select the route waypoint you want to review or change and press **EDIT/ENTER**. A pop-up menu with four route editing options will appear.

To review the selected waypoint:

1. Highlight the 'Review?' option and press **EDIT/ENTER**.

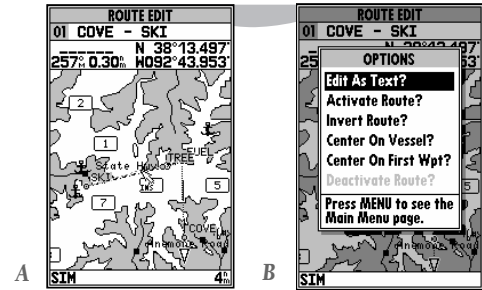
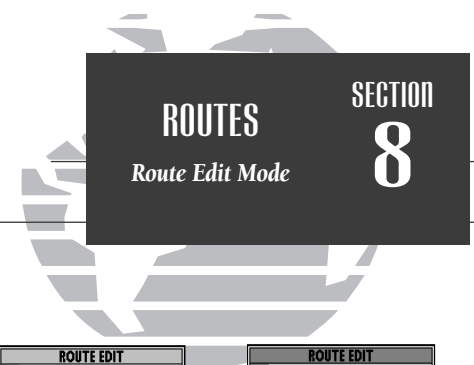

A. A new route waypoint may be inserted into any route leg by pointing to the new waypoint or position and pressing **EDIT/ENTER**.

B. The 'Edit As Text?' option allows you to review and modify waypoints by text data entry.

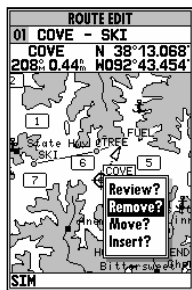

A

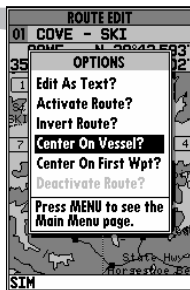

B

A. To remove a route waypoint, highlight the waypoint on the map, press EDIT/ENTER, and select the 'Remove?' option from the pop-up window.

B. The route edit options page lets you activate, invert, or deactivate the route you are editing. The 'Center On Vessel' and 'Center On First Wpt' options redraw the map to display the desired option.

To insert a new waypoint before the selected route waypoint:

1. Highlight the 'Insert?' option and press **EDIT/ENTER**.
2. Enter the name of the new waypoint using the **NUM** keypad, or press **MENU** to select the new waypoint from the nearest list, waypoint list, or map display.
3. Press **EDIT/ENTER** to finish.

To remove the selected route waypoint:

1. Highlight the 'Remove?' option and press **EDIT/ENTER**.

To change the selected route waypoint:

1. Highlight the 'Change?' option and press **EDIT/ENTER**.
2. Enter the name of the new waypoint using the **NUM** keypad, or press **MENU** to select the new waypoint from the nearest list, waypoint list, or map display.
3. Press **EDIT/ENTER** to finish.

The **route edit options page** features five more functions. These functions may be selected by highlighting the desired function and pressing **EDIT/ENTER**:

- **Activate Route?**— activates the route you are editing and begins navigation.
- **Invert Route?**— activates the route you are editing in reverse order and begins navigation.
- **Center On Vessel?**— redraws route edit map with your vessel in the center of the display.
- **Center On First Wpt?**— redraws route edit map with the first route waypoint in the center of the display.
- **Deactivate Route?**— stops navigation of the route currently selected.

To exit the route edit mode and return to the route list page, press the **QUIT** key.

Route List Page

The GPSMAP 230's **route list page** displays all the routes currently stored in memory in numerical order, with the route number and comment displayed. Route 00 is always reserved for the TracBack route, while routes 1-20 serve as storage routes (route 20 is stored as the GPSMAP tour route, which may be deleted at any time). From the list, you may enter your own 16-character route comment and select a specific route for activation, editing, or other management functions.

To enter a custom route comment:

1. Highlight the desired route and press **EDIT**.
2. Press the left arrow key of the **⬅** keypad to clear the comment field.
3. Use the **⬅** keypad to enter the new route comment and press **EDIT**.

Once you have selected a route from the route page, additional functions for that route are available from the route options page.

To display the route options:

1. Press **MENU**.

To select a menu option:

1. Highlight the desired option and press **EDIT**.

The following options are available from the route list page:

- **Create New Route?**— allows you to create a new route (see page 47).
- **Activate Route?**— activates the selected route and begins navigation.
- **Invert Route?**— activates the selected route in reverse order and begins navigation.
- **Edit On Map?**— allows you to edit the selected route on the map (see pages 48-49 for specific instructions).
- **Edit As Text?**— allows you to edit the selected route by text (see pages 49-50 for specific instructions).

ROUTES

Route List Page

SECTION 8

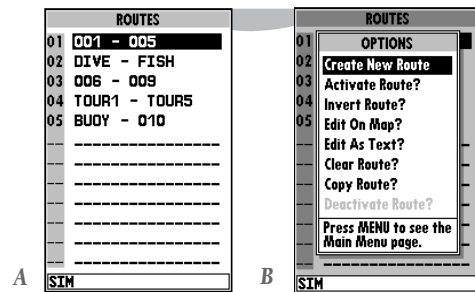

- A. The route list page displays each route stored in memory, along with a 16-character user comment. The default comment is the name of the first and last route waypoint.
- B. The route list options page provides quick access to many route functions, including activating and deactivating a selected route.

SECTION

8

ROUTES

Route List Options

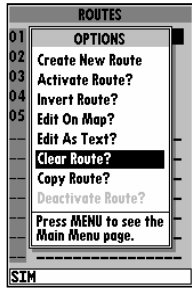

A

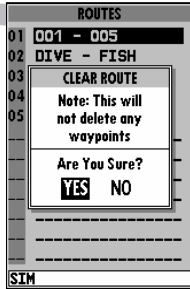

B

- A.** To delete all waypoints from a selected route, highlight the 'Clear Route?' option and press EDIT/ENTER.
- B.** Once a route is cleared, all waypoints are removed from the route. They are still stored in memory, however.

Route List Page Options (cont.)

- **Clear Route?**— allows you to clear all waypoints from the selected route.

To clear the selected route:

1. Highlight the 'Clear Route?' option and press **EDIT/ENTER**.
2. Press **EDIT/ENTER** to confirm the clear route warning.

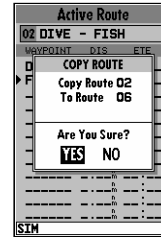

- **Copy Route?**— allows you to copy the waypoints of a selected route to another route. The route copy function can be used to copy a TracBack route (route 00) to another route in order to either prevent losing the route the next time a TracBack route is activated, or save a modified version of an existing route without losing the original.

To copy a route:

1. Highlight the 'Copy Route?' option and press **EDIT/ENTER**. The selected route will appear as the 'copy from' route, and the first open storage route will appear as the 'copy to' route.
2. Press **EDIT/ENTER** to confirm. (If you'd like to change the route number that is being copied or the open route which is being copied to, highlight the appropriate field and press **EDIT/ENTER**; select the new route number and press **EDIT/ENTER**.)

- **Deactivate Route?**— stops navigation of the route you are currently navigating.

SECTION 8

ROUTES Active Route Page Options

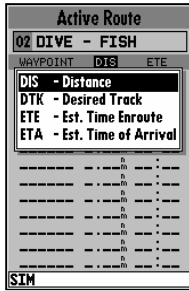

The 'Change Data Fields?' option lets you specify what information is displayed for each route waypoint. Four data options are available: distance, desired track, and ETA or ETE to each route waypoint.

Active Route Page Options

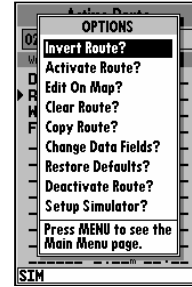

The following options are available from the active route page:

- **Invert Route?**— activates the active route in reverse order and begins navigation.
- **Activate Route?**— reactivates the active route and selects the route leg closest to your current position as the new active leg.
- **Edit On Map?**— allows you to edit the selected route on map (see pages 48-49 for specific instructions).
- **Clear Route?**— allows you to clear all waypoints from the selected route.
- **Copy Route?**— allows you to copy the waypoints of the active route to another route.
- **Change Data Fields?**— allows you to define the data displayed in the distance and ETE fields. Four data options are available:
 - DIS— distance to active wpt
 - DTK— desired track
 - ETE— estimated time enroute
 - ETA— estimated time of arrival
- **Restore Defaults?**— resets all active route page options to the factory settings.
- **Deactivate Route?**— stops navigation of the route you are currently navigating.
- **Setup Simulator?**— allows you to define speed, course, and position values while in simulator mode. See the Getting-Started Tour for more on using the simulator mode.

Track Log Submenu

The Main Menu Page's **track submenu** lets you specify whether or not to record a track plot (an electronic recording of your path) and define how it is recorded. It also provides an indicator of the track memory used and selects functions to clear the track memory and start a TracBack route. The following functions are available:

- **Record Mode**— lets you select one of three track recording options:
 - Off— No track log will be recorded. Note that selecting the 'Off' setting will prevent you from using the TracBack feature.
 - Fill— a track log will be recorded until the track memory is full.
 - Wrap— A track log will be continuously recorded, wrapping through the available memory (replacing the oldest track data with new data).
- **Interval**— defines the frequency with which the track plot is recorded. Three interval settings are available:
 - Time— records track plot based on a user-defined time interval.
 - Resolution— records track plot based upon a user-defined variance from your course over ground. The resolution option is the default setting and is recommended for the most efficient use of memory and TracBack performance. The distance value (entered in the interval field) is the maximum error allowed from the true course before recording a track point.
 - Distance— records track based on a user-defined distance between points.
- **Interval Value**— defines the distance or time used to record the track log.
- **Delete Track?**— allows you to clear the track log currently stored in memory.
- **Start TracBack?**— converts the current track log into an inverted route and begins route navigation along the track log.

To reset all track options to the default settings:

1. Press **MENU**, followed by **EDIT ENTER**.

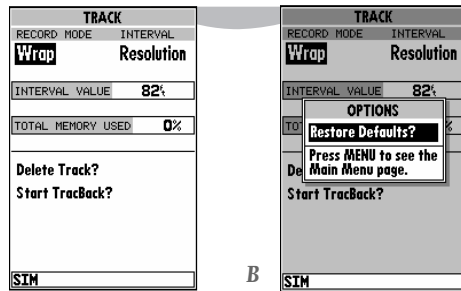

- A. The 'Wrap' option will continuously record a track log, and replace the oldest track log point with new data. The 'Fill' option will record a track log until the memory is full.
- B. The track submenu's default settings may be quickly restored from the track options page.

SETUP MENUS

Track Log Setup

SECTION 9

SECTION 9

SETUP MENUS Trip & Fuel Planning

TRIP & FUEL PLANNING	
PLAN	Point-To-Point
DIVE to FIS	---
SPEED	17.0 _t
FUEL FLOW	5.0 _{hr}
DEPART	15-APR-96 21:42 _z
DTK	094 _z
FUEL	9.7
DIS	33.0 _{mi}
ETE	01:56
ETA	23:38 _z
RISE	11:41 _z
DATE	15-APR SET
SET	00:54 _z
SIM	

TRIP & FUEL PLANNING	
PLAN	Point-To-Point
DIVE to FISH	
SPEED	17.0 _t
FUEL FLOW	5.0 _{hr}
DEPART	25-APR-96 21:42 _z
DTK	094 _z
FUEL	9.7
DIS	33.0 _{mi}
ETE	01:56
ETA	23:38 _z
RISE	11:27 _z
DATE	25-APR SET
SET	01:03 _z
SIM	

- A.** To perform point-to-point planning, enter a 'TO' and 'FROM' waypoint, or leave the field blank if you want to use your present position.
- B.** Enter a date and time for your departure. The sunrise/sunset and ETA at the 'TO' waypoint will be displayed at the bottom of the page.

Trip and Fuel Planning

The GPSMAP 230's **trip and fuel planning submenu** lets you plan and review distance, fuel, and ETE/ETA information between any two waypoints; your present position and a stored waypoint; or any part of a stored route. Sunrise and sunset information is also provided. Two planning modes are available: point-to-point and route planning.

To use the point-to-point planning mode:

1. Highlight the 'Trip & Fuel Planning' option from the Main Menu Page and press **EDIT ENTER**.
2. If the plan field is not set to 'Point-To-Point', press the **MENU** key and select it from the options page.
3. Highlight the first waypoint field and press **EDIT ENTER**. Press the left arrow key to clear the field, and use the **0** keypad to enter the name of the starting waypoint. You may leave the waypoint field blank to use your present position, or press the **MENU** key to select the waypoint from the nearest list, the waypoint list, or the map display. Press **EDIT ENTER** to confirm the waypoint.
4. Move the field highlight to the second waypoint field and follow the steps above to select the destination waypoint.
5. Enter a speed for your trip in the speed field, or press **MENU** to select your current SOG for the speed value.
6. Enter an hourly fuel flow (if desired) in the fuel field, and press **EDIT ENTER**.
7. Enter the date and time of your departure (the default date and time will be the current date and time in UTC or local time, whichever you have selected) and press **EDIT ENTER**.

The bottom of the page will now display the desired track and distance between the two points; the estimated time enroute and fuel required; the date and time of your arrival; and the sunrise and sunset times at the destination for the date of arrival.

The **route planning mode** lets you calculate the same planning information for any route stored in memory, in leg or cumulative leg, or route totals.

To use the route planning mode:

1. Highlight the 'Trip & Fuel Planning' option from the Main Menu and press **EDIT ENTER**.
2. If the plan field is not set to 'Route', press **MENU** and select it from the options page.
3. Highlight the route number field and press **EDIT ENTER**.
4. Use the **⬇️** keypad to select the route you want to plan and press **EDIT ENTER**.
5. Highlight the leg field and press **EDIT ENTER**.
6. To plan the cumulative totals for the all route legs, select the 'ALL' option—or use the **⬇️** keypad to select a specific route leg to plan. Press **EDIT ENTER** to confirm.
7. Enter a speed for your trip, or press **MENU** to select your current SOG for the speed value.
8. Enter an hourly fuel flow (if desired) in the fuel field, and press **EDIT ENTER**.
9. Enter the date and time of your departure (the default date and time will be the current date and time in UTC or local time, whichever you have selected) and press **EDIT ENTER**.

The bottom of the page will now display the planning information for the route leg selected or the cumulative values for the entire route. The route planning mode will also let you plan cumulative totals for multiple route legs by using the 'Hold First Waypoint?' selection from the options window.

To plan multiple route legs:

1. Follow steps 1 through 6 above to select the last route leg you want to plan. For example, select leg 03 if you want to plan cumulative totals for the first three legs of the route (without including the rest of the route).
2. Enter the speed, fuel and date/time values as described in steps 7-9 above.
3. Press the **MENU** key to display the options page.
4. Select the 'Hold First Waypoint?' option and press **EDIT ENTER**. The cumulative totals from the first route waypoint to the end of the selective leg will appear at the bottom of the page.

SETUP MENUS

SECTION

Route & Trip Planning

9

TRIP & FUEL PLANNING		
PLAN	ROUTE	LEG
Route	02	ALL
DIVE to FISH		
SPEED	17.0 ^h	
FUEL FLOW	5.0 ^{hr}	
DEPART	25-APR-96 21:42 ^z	
DTK	___ ^o	FUEL 14.1
DIS	47.9%	ETE 02:49
ETA	00:31 ^z	RISE 11:26 ^z
DATE	26-APR	SET 01:04 ^z
SIM		

A

TRIP & FUEL PLANNING		
PLAN	ROUTE	LEG
Route	02	02
REEF to WRECK		
SPEED	23.0 ^h	
FUEL FLOW	4.0 ^{hr}	
DEPART	15-APR-96 21:59 ^z	
DTK	144 ^o	FUEL 3.1
DIS	17.9%	ETE 00:47
ETA	22:46 ^z	RISE 11:43 ^z
DATE	15-APR	SET 00:55 ^z
SIM		

B

- A. To plan cumulative totals for an entire route, select the 'All' option from the leg field.
- B. To plan cumulative totals through a particular leg, select the 'Hold First Waypoint?' option from the Trip and Fuel Planning options page. Then enter the last leg you want to plan in the leg field.

- **Local/UTC** lets you choose to display the date and time in UTC (Greenwich Mean Time) time or local time offset from UTC time. The default setting is local with a '0' offset. (If you are boating in the United States, be sure to enter a negative time indicator in front of the appropriate time offset for your location).
- **Tone Selection** lets you select an audible tone to sound for either messages and keystroke confirmation (the default setting), messages only, or not to sound at all (the tone selection does not affect the external alarm operation).
- **Display Contrast** provides a slide bar to adjust the LCD screen contrast in order to compensate for changes in temperature or lighting conditions.
- **Backlight Timeout** provides an automatic shutoff for the GPSMAP 230's screen backlighting. Six settings are available: No Timeout (the backlight will stay on until it is turned off), 15 seconds (default setting); 30 seconds; and 1, 2, or 4 minutes. Keeping the timeout at the lowest acceptable setting will prolong the life of the backlight.
- **Language** lets you select one of nine languages that the unit can display. The available languages are; English, Danish, Finnish, French, German, Italian, Portuguese, Spanish, Swedish.



The system setup page also features an options page that allows you to quickly reset all the system setup options to the factory default settings and define speed, course and position values while in simulator mode (see Getting-Started Tour).

To view the system setup page options:

1. Press the **MENU** key.

To restore the default settings:

1. Highlight the 'Restore Defaults?' option, and press **EDIT/ENTER**.

SETUP MENUS SECTION 9

System Setup & System Setup Options

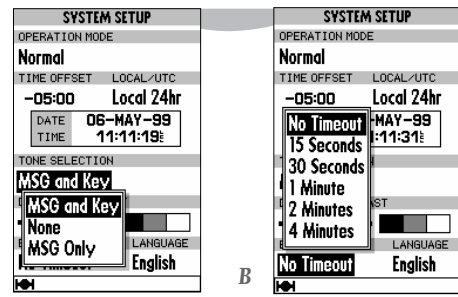

- A. The tone preference will not affect external alarm operation.
- B. Keeping the backlight timeout at the lowest acceptable setting will prolong the useful life of the backlight.

SECTION 9

SETUP MENUS Navigation Setup

Navigation Setup

The navigation setup submenu is used to select a variety of navigation information including: position format, units of measure, and heading preferences. This submenu is also used to select map datums, set the CDI scale and adjust the built-in velocity filter. The following options are available:

- **Position Format** lets you select the coordinate system used to display position. The following formats are available:
 - hddd°mm.mmm' (degrees)
 - hddd°mm'ss.s" (deg/min/sec)
 - German Grid
 - Irish Grid
 - Maidenhead
 - New Zealand
 - Swedish Grid
 - Swiss Grid
 - Taiwan Grid
 - Loran TD
 - hddd°mm.mmm' (degrees and minutes)
 - British grid
 - Irish grid
 - Swedish grid
 - Taiwanese grid
 - Loran TD

For more information on the Loran TD position format see Appendix ? on page ?

- **Navigation Units** selects the format for speed and distance measurements. You may select from nautical, statute, or metric formats. (The default setting is nautical.)
- **Depth Units** selects the format for depth contour display on G-chart offshore chart cartridges. Depth contours can be displayed in feet, meters, or fathoms. (The default setting is feet.)
- **Heading** lets you select what reference is used in calculating heading information. You can select to reference automatic magnetic variation, true north, grid heading, or user magnetic variation. (The default setting is automatic.)

To enter a user magnetic variation:

1. Highlight the 'Heading' field and press **EDIT ENTER**. Select the 'User Mag Var' option and press **EDIT ENTER**.
 2. Press **EDIT ENTER** to access the variation field, and use the **0** keypad to enter the desired variation. Press **EDIT ENTER** to confirm.
- **CDI Scale** provides a list of six CDI scale settings for the map page CDI: +/-0.10, 0.50, 1.0 (default), 5.0, 10.0, and 25.0 miles or kilometers. The scale represents the distance from the center of the scale to either end of the scale.

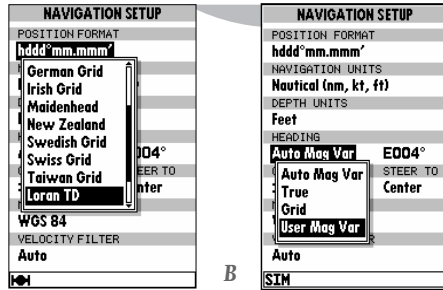

A. The GPSMAP 230 will also display position coordinates in eight grid formats.

B. To enter a user magnetic variation, select the 'User Mag Var' option and enter a direction and value in the variation field.

SETUP MENUS

Navigation Setup

SECTION 9

- **CDI Steer To** allows you select a steer-to-center or steer-to-D-Bar orientation for graphic steering guidance. The steer-to-center selection displays your position as the vertical line on the scale, and your desired track as the center of the scale. The steer to D-Bar option displays your position as the center of the scale, with the desired track as the vertical line. The default setting is steer to center.
- **Map Datum** provides a list of the available map datums for use with the GPSMAP system. For a list of the available GPSMAP datums, see Appendix D. The default setting is WGS 84.
- **Velocity Filter** allows you to select the GPSMAP's response time to changes in track or ground speed. Three settings are available: automatic, on, or off. The 'auto' (default) setting will monitor the changes in your current track and speed and adjust the receiver's response time automatically. The 'on' setting allows you to manually enter a response time up to 240 seconds. Selecting a higher setting may be desirable in slow-speed applications with frequent changes in track.



To enter a user defined velocity filter value:

1. Highlight the 'Velocity' field and press **EDIT ENTER**. Select the 'On' option and press **EDIT ENTER**.
2. Highlight the time value field.
3. Press **EDIT ENTER**.
4. Enter a value in seconds (up to 240) and press **EDIT ENTER** to confirm.

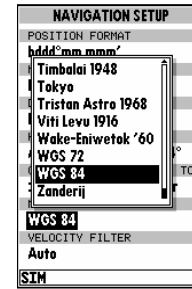

A

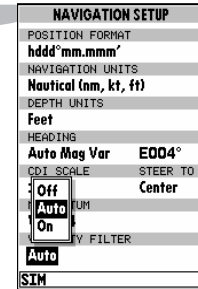

B

- A. **CAUTION!** Using the incorrect map datum can seriously effect the accuracy of your GPS receiver. The GPS datum should always match the datum of the local chart you are using. If no datum information is indicated on the charts you are using, contact the chart manufacturer.
- B. Keeping the velocity filter on the 'Auto' setting will allow the GPSMAP 230 to automatically monitor and adjust the response time for track and speed calculations.

SECTION

9

SETUP MENUS

Timers & Alarms

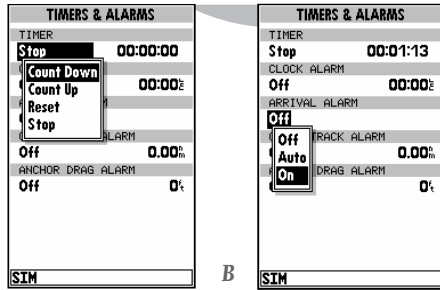

A. The timer field can be set to count down from a specified interval or provide a running count of elapsed time.

B. The 'On' setting of the arrival alarm will cause the alarm to sound only for the final destination waypoint of a route at the distance specified.

Timers & Alarms Setup

The timer & alarms submenu is used to control various alarm/timer settings.

- **Timer** sounds an alarm when an entered interval (up to 99:59:59) has expired, or provides a continuous running clock timer to 99:59:59.

To use the countdown timer:

1. Select the 'Count Down' menu option.
2. Enter the desired time interval in the interval field, and press **EDIT/ENTER**.
3. Once the count down time has expired, an alarm message will appear, and the timer will automatically switch to the count up mode.
4. To reset the timer, select the reset option and press **EDIT/ENTER**.

- **Clock Alarm** provides an alarm for the system clock. To use the clock alarm, select the 'On' option and enter the desired time of day in the time field.
- **Arrival Alarm** lets you specify an alarm to sound when you're a specified distance away from a destination waypoint. Three options are available:
 - Off- No arrival alarm will sound.
 - Auto- An arrival alarm will sound one minute before the destination, based upon your current speed and course over ground.
 - On- An arrival alarm will sound at the alarm distance specified in the distance field for the destination waypoint (the 'On' setting will only provide an arrival alarm for the final destination waypoint of the active route).
- **Crosstrack Alarm** provides an alarm for crosstrack error (XTK) when your vessel is off course by more than a specified distance, up to 99.99 (units).
- **Anchor Drag Alarm** lets you specify an alarm to sound when you've exceeded a specified drift distance, up to 9999 (units). Whenever the anchor alarm is triggered, an anchor icon will appear in the status bar.

Input/Output Submenu

The Input/Output submenu lets you control interface settings for connecting external NMEA devices, a DGPS receiver, or a personal computer. The 'Input/Output Format' field, at the top of the page, lets you specify one of seven interface formats:

Data Transfer is a proprietary interface that allows you to exchange data such as waypoints, routes, and track logs between GPSMAP units or a GARMIN PC kit.

No In/NMEA Out provides navigation information to a compatible NMEA device such as an autopilot or radar. NMEA 0180, 0182, 0183 v.1.5 and 0183 v.2.0 output options are available. See Appendix B for additional NMEA sentence information.

No In/No Out provides no interfacing capabilities.

RTCM In/NMEA Out allows DGPS beacon receiver input and also provides selectable NMEA output.

RTCM In/No Out allows DGPS beacon receiver input, with no output capabilities.

NMEA In/No Out allows input from a NMEA compatible external device, such as a Yeoman© Plotter, with no output capabilities.

NMEA In/NMEA Out provides the same input capabilities as NMEA IN, with selectable NMEA output.

When the 'Data Transfer' option is selected, you'll need to specify what information to request or send to the remote unit through the 'Transfer Mode' field. The 'slave' setting lets you control all data transfer from the 'external' GPS receiver, or PC while the other settings request or send specific data from the primary unit.

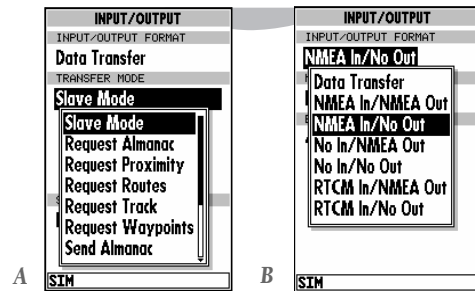
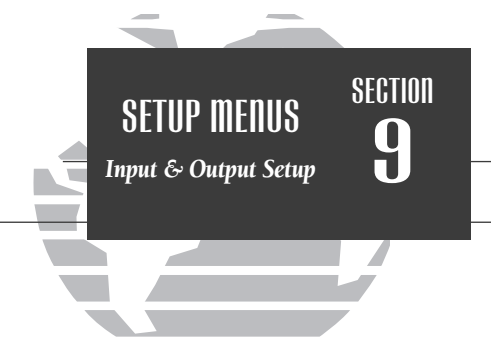

- A. The data transfer options allow you to send or receive almanac data, proximity waypoints, routes, track log data, and waypoints to another GARMIN GPS or PC kit.
- B. The NMEA In setting allows you to accept NMEA data from a Yeoman plotter or other compatible device.

SECTION

9

SETUP MENUS

NMEA & DGPS Setup

INPUT/OUTPUT
INPUT/OUTPUT FORMAT
NMEA In/No Out
NMEA FORMAT
NMEA 0183 V2.0
NMEA 0180
NMEA 0182
NMEA 0183 V1.5
NMEA 0183 V2.0
SIM

A

INPUT/OUTPUT
INPUT/OUTPUT FORMAT
RTCM In/NMEA Out
NMEA FORMAT
0 bps (auto) 2.0
25 bps
50 bps
100 bps
200 bps
R TUNE TO
R BIT RATE
100 bps
STATUS SNR
No Status --- dB
SIM

B

- A.** Select the desired format from the NMEA field. The baud rate will automatically be set to the appropriate speed.
- B.** After entering a DGPS frequency, set the bit rate to the speed indicated on the USCG station chart. DGPS coverage, frequencies, and bit rates are available from the Coast Guard's automated FAX service (703-313-5920).

Using NMEA & DGPS Interface Settings

If you are using an NMEA interface format, the NMEA format must be specified in the NMEA format field that will automatically appear when an NMEA option is selected. The appropriate baud rate will be set automatically.

To select an NMEA format:

1. Select a NMEA IN/OUT format from the options page.
2. Highlight the NMEA Format field and press **EDIT ENTER**.
3. Select a NMEA sentence format and press **EDIT ENTER**.
4. The baud rate will automatically be set to the appropriate speed. If you have selected an NMEA IN/OUT setting, you must use the same NMEA format for both the input and output device.

Tuning DGPS Stations

If the I/O Format is set to accept RTCM input/NMEA Output for connecting a differential-ready GPS beacon receiver, you will need to tune a frequency in the tuning field and select a bit rate. The default frequency will be 304.0 kHz, with a bit rate of 100 bps, or the last DGPS frequency/bit rate selected.

To tune a DGPS frequency:

1. Select the 'RTCM In/NMEA Out' format from the options page.
2. Highlight the beacon receiver frequency field and press **EDIT ENTER**.
3. Enter the desired frequency and press **EDIT ENTER**. If you are using an automatically-tuned DGPS receiver, you may enter 000.0 for the frequency.
4. Press **EDIT ENTER** to select a bit rate. Five bit rates are available: 0 (used for automatically-tuned DGPS receivers), 25, 50, 100 and 200 bps. Press **EDIT ENTER** to confirm. The DGPS status, along with the signal-to-noise ratio of the tuned station, will be displayed at the bottom of the page.

Installing & Removing G-chart Cartridges

The GARMIN GPSMAP 230 system uses G-chart offshore or inland cartography to display digital charts on-screen. G-chart cartridges are installed in the card slot located at the bottom right of the GPSMAP unit. G-chart cartridges may be installed or removed at any time, whether the unit is on or off.

To install a G-chart cartridge:

1. Open the cartridge door on the GPSMAP 230 unit.
2. Insert the card (label facing front and G-chart logo at top) into the slot.
3. Use your thumb to firmly push the cartridge into place. If your GPSMAP 230 is on, a confirmation tone will sound when the cartridge has been properly installed and accepted.
4. Close the door (Note: The door will not close unless the G-chart is fully inserted.).



If you insert a G-chart cartridge and get a 'card format not recognized' message, try removing the card and reinserting it. If the card is still not recognized, contact the dealer you purchased it from for assistance. G-chart cartridges are not waterproof, should not be exposed to moisture or excessive static charges, and should be stored in the anti-static bag supplied with the cartridge.

To remove a G-chart cartridge:

1. Open the cartridge door.
2. Grasp the card at the bottom groove and pull firmly.
3. If your GPSMAP is on, a confirmation tone will sound when the G-chart cartridge has been removed.

G-CHARTS

Installing &
Removing G-charts

SECTION 10

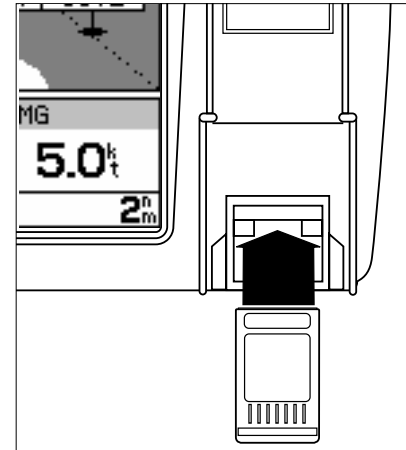

SECTION 10

G-CHARTS

Using G-chart Cartography

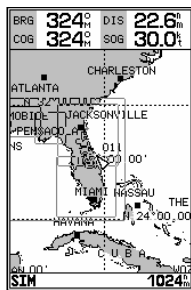

A

A. Map outlines for G-chart offshore cartography.

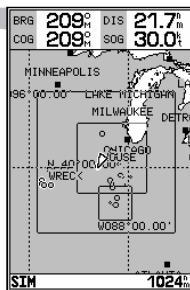

B

B. Map outlines for G-chart inland cartography.

Note: The smaller boxes located within larger boxes indicate areas of greater detail.

Using G-chart Cartography

Once a G-chart cartridge has been inserted, the map coverage outlines for the cartridge will automatically appear on-screen. Keep in mind that the display will not automatically scroll to the map area or zoom to a level where you can see the coverage outlines. If you do not immediately see the outlines, scroll the cursor to the broad geographic area covered by the chart and zoom out to another map scale.

The large outlined box shown is the main chart, which serves as the boundary area for the entire cartridge. The small outlined box inside the main box are sub-charts, which provide more detailed coverage of the area indicated. To view the detailed cartography of any subchart, scroll the cursor to the subchart outline and use the **IN** key to zoom in to smaller range scales. If the map outlines still do not appear, check the 'Map Outlines' setting on the map options page to make sure they are set to appear (see page 26).



Whenever you zoom past the usable range of the current electronic chart, the range field will display 'Ovr Zm' or 'No Map'. These warnings indicate that although you may still have cartography, you should exercise extreme caution using the data. See page 25 for more information on Overzoom and No Map modes.

When a G-chart cartridge is installed, the GPSMAP 230's system will automatically use the best available chart for display. As you enter and exit various sub-charts, the system will automatically display the appropriate chart for the area you are in. When you leave the area covered by the main map of a cartridge, the GPSMAP 230 will default back to using the built-in 64 nm database if it is available at the current scale.

If you are not seeing certain map items (navaids, depth contours, etc. on offshore cartridges; highways, boat ramps, etc. on inland cartridges), check the map configuration settings available from the map options page.

Installing the GPSMAP 230

The GPSMAP 180 must be properly installed according to the following instructions to get the best possible performance. The GPS antenna should be installed first, followed by the display unit. To complete the installation, you'll need the appropriate fasteners for your installation, and a 1" x 14-thread marine antenna mount available at most marine dealers.

Mounting the GPS antenna

The antenna should be mounted in a location that has a clear, unobstructed view of the sky in all directions to ensure the best reception. Avoid mounting the antenna where it will be shaded by the boat's superstructure, a radome antenna, or mast. Sailboat users should avoid mounting the antenna high on the mast to prevent inaccurate speed readings caused by excessive heeling. Most marine VHF and loran antennas will not seriously degrade the GPS antenna's reception. Never paint the antenna or clean it with harsh solvents.

The GARMIN antenna screws directly onto any standard 1" x 14-thread antenna mount. If you need to raise the antenna to avoid shading, try using a 1" x 14-thread extension mast available at most marine dealers.

To install the GPS antenna:

1. Screw the antenna directly onto the 1" x 14-thread mount.
2. Route the cable to the mounting location of the display unit. Use the appropriate tie-wraps, escutcheon plates, and sealant to secure the cable along the route and through any bulkhead or deck.
3. Once the GPSMAP unit has been installed, connect the cable to the antenna connector on the back of the display unit. Make sure that you turn the antenna-connector locking ring 1/4 turn clockwise to lock the cable into place.



It is possible to route the coaxial cable either through, or outside the antenna mount. The BNC connector on the coaxial cable can be removed, and the coaxial cable shortened to ease installation. If the BNC connector is removed, it must be replaced with a new BNC connector.



Mounting the GPSMAP 230 Unit

The GPSMAP 230's water-resistant case is suitable for mounting in exposed locations or at the nav station. The unit comes with a mounting bracket and a gimbal mount to allow surface or overhead mounting. When choosing a location for the display unit, make sure you consider the following conditions:

- There should be at least a 3" (7.5 cm) clearance behind the case to allow connection of the antenna and power/data cables.
- The unit should not be mounted where it is exposed to excessive temperatures for extended periods (see page 71).
- You should provide adequate clearance for the G-chart cartridge to slide out completely.
- The mounting surface should be heavy enough to support the unit and protect it from excessive vibration and shock.
- For flush mounting, make sure the flat panel is between 0.04" and 0.30" (1.0 to 7.6 mm) thick if you intend to use the cam lobe built into the mounting bracket.

To surface mount the GPSMAP unit:

1. Place the gimbal mount in the desired location.
2. Mark and drill the four mounting holes for the fastener you are using. Note that the GPSMAP 230 may also be used with a Johnny Ray JR-300 swivel mount.
3. Fasten the gimbal mount to the surface using the appropriate fasteners.
4. Insert the GPSMAP 230 into the gimbal mount. The mount is designed for a tight fit to provide additional support when swiveling the unit.
5. Screw the two mounting knobs through the gimbal mount and into the mounting bracket.
6. Connect the power/data and antenna cables to the back of the unit, making sure the locking rings are tightened on both connectors.

To flush mount the GPSMAP 230

1. Remove the four M5 screws from the back of the unit and remove the mounting bracket .
2. Using the mounting template provided in the box, determine the location where you want to mount the unit and tape the template in place.
3. Using a hammer and center punch, mark the centers of the mounting screw holes.
4. Drill the four 0.25" screw holes, using a 1/4" drill bit
5. Cut the center relief section from the panel.
6. From the front, place the GPSMAP 230 into the relief hole until the unit rests flush against the mounting surface.
7. Secure the unit to the mounting surface using M5 screws.

Note: For thick mounting surfaces, insert the M5 screws directly thru the four drilled holes (figure 1). For thin panels, place the mounting bracket on the back side of the panel for more support (figure 2).

8. Attach the power/data cable and antenna connectors.

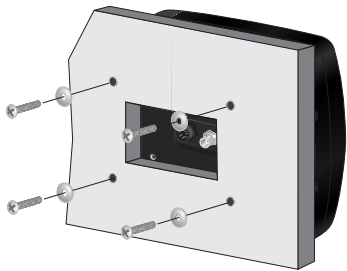

Figure 1

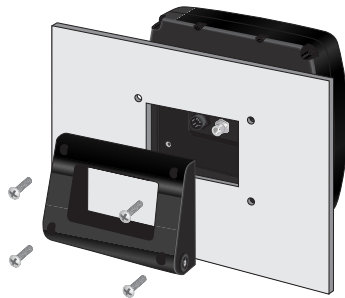
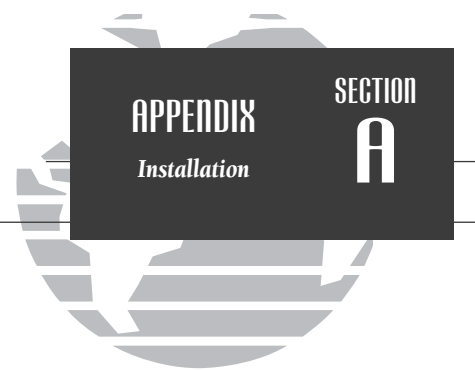
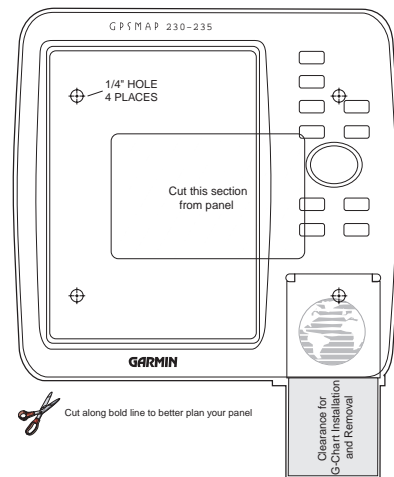

Figure 2



Mounting Template



Mounting template provided in box

SECTION B

APPENDIX Wiring & Specifications



DGPS corrections are accepted in RTCM-104 v. 2.0 format through the NMEA In (BROWN) harness lead. The GARMIN GBR 21 is the recommended beacon receiver for use with the GPSMAP system. Other receivers with the correct RTCM format may be used, but may not correctly display status or allow tuning control from the GPSMAP unit.

Connecting the Power/Data Cable

The power/data cable connects the GPSMAP 230 to a 10-40 volt DC system and provides interface capabilities for connecting external devices, including an external alarm. The color code in the diagram below indicates the appropriate harness connections.

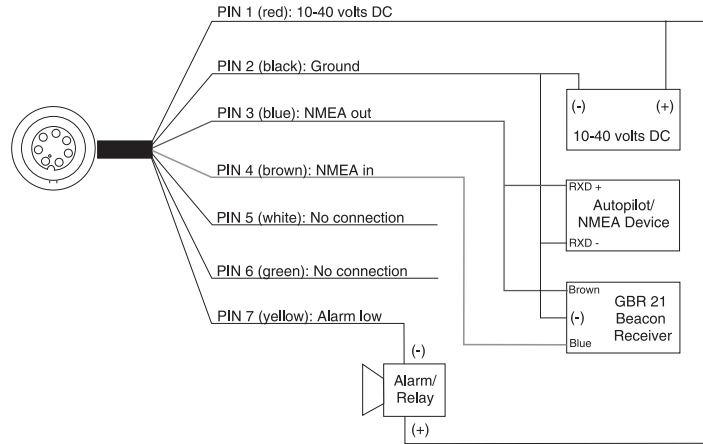

The following formats are supported for connection to up to 3 NMEA devices:

- NMEA 0180/NMEA 0182
- NMEA 0183 version 1.5
 - Approved sentences— GPBWC, GPGLL, GPRMB, GPRMC, GPXTE, GPVTG, GPWPL, GPBOD
 - Proprietary sentences— PGRMM, PGRMZ (alt.), PSLIB (beacon receiver control input)
- NMEA 0183 version 2.0
 - Approved sentences— GPGGA, GPGLL, GPGSA, GPGSV, GPRMB, GPRMC, GPRTE, GPWPL, GPBOD
 - Proprietary sentences— PGRME (estimated error), PGRMM (map datum), PGRMZ (altitude), PSLIB (beacon rec. control input)

GPSMAP 230 Specifications

PHYSICAL

Case:	Gasketed Construction
Size:	7.55"H x 7.7"W x 2.57"D (19.18 cm x 19.56 cm x 6.53 cm)
Weight:	2.0 Lbs (.907 Kg)
Temperature Range:	5° to 158°F (-15° to 70°C)

PERFORMANCE (GPSMAP 230)

Receiver:	12-channel PhaseTrac12
Acquisition Time:	Approx. 15 seconds (warm) Approx. 45 seconds (cold) Approx. 5 minutes (AutoLocate™) Approx. 5 minutes (Search the sky)
Update Rate:	1/second, continuous
Position Accuracy:	1-5 meters (3-16 ft.)* 15 meters (49 ft.) RMS**
Velocity Accuracy:	0.1 knot RMS steady state, 90 knots max.
Dynamics:	Performs to specification to 6g ³

POWER

Input:	10-40v DC
Usage:	10 watts max.

Specifications subject to change without notice.

* With optional GARMIN GBR 21 Beacon Receiver Input.

** Subject to accuracy degradation to 100m 2DRMS under the U.S. DOD-imposed Selective Availability Program.

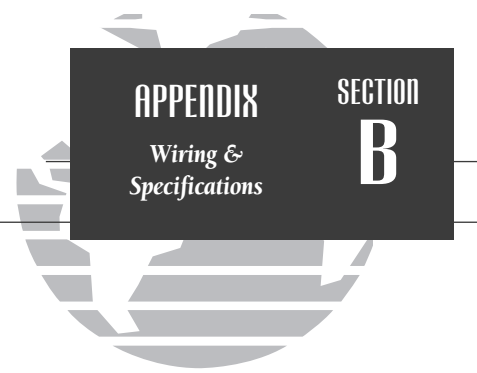

WARNING!

The temperature range for the GPSMAP 230 is -4 to +158°F (-20 to 70°C). Extended exposure to temperatures exceeding this range (in storage or operating conditions) may cause failure of the LCD screen. This type of failure and related consequences are NOT covered by the manufacturer's limited warranty.

The GPSMAP 230 uses an on-screen message prompt to alert you to important information. Whenever a message appears, press the **PAGE** key to view the message.

Alarm Clock—The alarm clock has sounded.

Anchor Drag Alarm—You have drifted out of the specified distance range.

Approaching—You are less than one minute away from reaching a destination waypoint at your present speed over ground.

Arrival At—You have arrived at the destination waypoint.

Can't Change An Active Waypoint—You have attempted to change the “active to” or “active from” waypoint. Clear the active route or GOTO before making your changes.

Card Format is Not Recognized—The cartridge inserted is not readable by the GPSMAP system and may be damaged. Reinsert the cartridge to make sure it is properly installed. If the cartridge is still not recognized, call the G-chart information line at 1-800-427-6460.

Cross-Track Alarm—You have exceeded the off-course distance specified in the CDI setup.

Data Transfer is Complete—The receiver is finished uploading or downloading information to the connected device.

Database Memory has Failed—The built-in 64 nm database has failed. See an authorized service center for repair.

Degraded Accuracy—The accuracy of your GPSMAP system has been degraded beyond 500 meters due to poor satellite geometry or data quality. You should check other navigational sources to verify the position indicated.

Max Calibration Is 5000mt (16,400 ft)—You have exceeded the maximum possible map calibration.

Memory Battery Power is Low—The internal battery that stores waypoints, routes, and track plots needs to be replaced. Take your unit to an authorized GARMIN service center for installation of a new battery.

Need Altitude—Your GPSMAP system needs the altitude to maintain a position fix due to poor satellite coverage. Enter your approximate altitude on the initialize position page.

Need to Select Init Method—The GPSMAP 230 needs to be initialized to your present position. See pages 1-2 for complete instructions on initialization.

No Differential GPS Position—Not enough data is being received to compute a DGPS position.

Oscillator Needs Adjustment—The GPSMAP 230 has detected excessive drift in its internal oscillator, which may result in longer acquisition times. Take the unit to an authorized GARMIN service center for adjustment.

Poor GPS Coverage—The GPSMAP 230 cannot acquire the necessary number of satellites to compute a position.

Power Down and Re-init—The GPSMAP 230 cannot calculate a position due to abnormal satellite conditions. Power down and verify the last position shown by other means.

Proximity Alarm—You have entered the alarm radius for the proximity waypoint indicated.

Proximity List Full—You have used all nine proximity waypoints.

Proximity Overlaps Another Prox Wyp—The alarm radius specified overlaps the area specified for another proximity waypoint.

RAM has Failed—The random access memory has failed and the unit is not operable. Take your unit to an authorized GARMIN service center for repairs.

ROM has Failed—The unit's permanent memory has failed and the unit is not operable. Take your unit to an authorized GARMIN service center for repairs.

Received Invalid Waypoint—A waypoint was received during upload transfer that has an invalid identifier.

Receiver has Failed—A failure in receiver hardware has been detected. If this message persists, do not use the unit and take it to an authorized dealer for repair.

Route Already Exists—The route number you are trying to copy to is already used.

Route Does Not Exist—The route number you are trying to use or copy is not defined.

Route is Full—You have attempted to add more than 30 waypoints to a route.

Route Memory is Full—You have attempted to create more than 20 routes.

Route Waypoint was Deleted—A route waypoint entered does not exist in the database and has been deleted from the route.

RTCM Input has Failed—DGPS data being received has been lost. You are no longer receiving the beacon signal.

Searching the Sky—The GPSMAP 230 is searching the sky for almanac data.

Stored Data was Lost—All waypoints, routes and almanac data has been lost due to internal battery failure.

There is No RTCM Input—The beacon receiver is not properly connected or baud rates do not match.

Timer Has Expired—The countdown timer has expired.

Track Memory is Full—The track memory is full and no additional track plot will be recorded until the track memory has been cleared or set to wrap mode.

Wyp Already Exists—The waypoint name you've entered already exists in memory.

Waypoint Memory is Full—You have used all 250 waypoints in the GPSMAP 230 system.

**Corrego Alegre
Djakarta**

Dos 1968

**Easter Isld 67
European 1950**

European 1979

**Finland Hayfrd
Gandajika Base**

Geod Datm '49

**Guam 1963
Gux I Astro
Hjorsey 1955**

**Hong Kong '63
Hu-Tzu-Shan
Indian Bngldsh**

**Indian Thailand
Indonesia '74**

**Ireland 1965
ISTS 073 Astro**

Johnston Island

Kandawala

Corrego Alegre- Brazil
Djakarta (Batavia)- Sumatra
Island (Indonesia)

Dos 1968- Gizo Island
(New Georgia Islands)
Easter Island 1967

European 1950- Austria,
Belgium, Denmark,
Finland, France, Germany,
Gibraltar, Greece, Italy,
Luxembourg, Netherlands,
Norway, Portugal, Spain,
Sweden, Switzerland

European 1979- Austria,
Finland, Netherlands,
Norway, Spain, Sweden,
Switzerland

Finland Hayford- Finland
Gandajika Base- Republic
of Maldives

Geodetic Datum '49-
New Zealand

Guam 1963- Guam Island
Guadalcanal Island

Hjorsey 1955- Iceland
Hong Kong

Taiwan
Indian- Bangladesh, India,
Nepal

Indian- Thailand, Vietnam
Indonesia '74

Ireland 1965- Ireland
ISTS 073 ASTRO '69-
Diego Garcia

Johnston Island Kandawala
Kandawala- Sri Lanka

Sri-Lanka

**Kerguelen Islnd
Kertau 1948
L. C. 5 Astro
Liberia 1964
Luzon Mindanao
Luzon Philippine**

Mahe 1971

Marco Astro

Massawa

Merchich

Midway Ast '61

Minna

NAD27 Alaska

NAD27 Bahamas

NAD27 Canada

NAD27 Canal Zone

NAD27 Caribbean

NAD27 Central

NAD27 CONUS

NAD27 Cuba

Kerguelen Island
West Malaysia, Singapore
Cayman Brac Island

Liberia 1964- Liberia
Luzon- Mindanao Island
Luzon- Philippines
(excluding Mindanao Isl.)

Mahe 1971- Mahe Island
Marco Astro- Salvage Isl.
Massawa- Eritrea (Ethiopia)
Merchich- Morocco

Midway Astro '61- Midway
Minna- Nigeria

North American 1927-
Alaska

North American 1927-
Bahamas (excluding San
Salvador Island)

North American 1927-
Canada and Newfoundland
North Am. 1927- Canal
Zone

North American 1927-
Caribbean (Barbados,
Caicos Islands, Cuba,
Dom. Rep., Grd. Cayman,
Jamaica, Leeward and
Turks Islands)

North American 1927-
Central America (Belize,
Costa Rica, El Salvador,
Guatemala, Honduras,
Nicaragua)

North Am. 1927- Mean
Value (CONUS)

North American 1927-
Cuba



APPENDIX
Map Datums

SECTION
D

NAD27 Greenland	North American 1927- Greenland (Hayes Peninsula)	Reunion	Reunion- Mascarene Island
NAD27 Mexico	N. American 1927- Mexico	Rome 1940	Rome 1940- Sardinia Isl.
NAD27 San Salvadr	North American 1927- San Salvador Island	RT 90	Sweden
NAD83	North American 1983- Alaska, Canada, Central America, CONUS, Mexico	Santo (Dos)	Santo (Dos)- Espirito Santo
Nahrwn Masirah lnd	Nahrwn- Masirah Island (Oman)	Sao Braz	Sao Braz- Sao Miguel, Santa Maria Islands
Nahrwn Saudi Arbia	Nahrwn- Saudi Arabia	Sapper Hill '43	Sapper Hill 1943- East Falkland Island
Nahrwn United Arab Emirates	Nahrwn- United Arab Emirates	Schwarzeck	Schwarzeck- Namibia
Naparima BWI	Naparima BWI- Trinidad and Tobago	South American '69	S. American '69- Argentina, Bolivia, Brazil, Chile, Colombia, Ecuador, Guyana, Paraguay, Peru, Venezuela, Trin/Tobago
Obsrvtorio '66	Observatorio 1966- Corvo and Flores Islands (Azores)	South Asia	South Asia- Singapore
Old Egyptian	Old Egyptian- Egypt	Southeast Base	Southeast Base- Porto Santo and Madiera Islands
Old Hawaiian	Old Hawaiian- Mean Value	Southwest Base	Southwest Base- Faial, Graciosa, Pico, Sao Jorge and Terceira Islands
Oman	Oman- Oman	Timbalai 1948	Timbalai 1948- Brunei and E. Malaysia (Sarawak and Sabah)
Ord Srvy Grt Britn	Old Survey Grt Britn- England, Isle of Man, Scotland, Shetland Isl., Wales	Tokyo	Tokyo- Japan, Korea, Okinawa
Pico De Las Nieves	Canary Islands	Tristan Astro '68	Tristan Astro 1968- Tristan da Cunha
Potsdam	Germany	Viti Levu 1916	Viti Levu 1916- Viti Levu/ Fiji Islands
Pitcairn Astro '67	Pitcairn Astro '67- Pitcairn	Wake-Eniwetok	Wake-Eniwetok- Marshall
Prov So Amrcin '56	Prov So Amrcin '56- Bolivia, Chile, Colombia, Ecuador, Guyana, Peru, Venezuela	WGS 72	World Geodetic System 72
Prov So Chilean '63	So Chilean '63- S. Chile	WGS 84	World Geodetic System 84
Puerto Rico	Puerto Rico & Virgin Isl.	Zanderij	Zanderij- Surinam
Qatar National	Qatar National- Qatar		
Qornoq	Qornoq- South Greenland		

Almanac Data—The satellite constellation information (including location and health of satellites) that is transmitted to your receiver from every GPS satellite. Almanac data must be acquired before GPS navigation can begin.

Bearing (BRG)—The compass direction from your position to a destination.

Course Over Ground (COG)—Direction of movement relative to a ground position.

Crosstrack Error (XTK)—The distance you are off a desired course in either direction.

Desired Track (DTK)—The compass course between the “from” and “to” waypoints.

Differential GPS (DGPS)—An extension of the GPS system that uses land-based radio beacons to transmit position corrections to GPS receivers.

Estimated Time of Arrival (ETA)—The time of day of your arrival at a destination.

Estimated Time Enroute (ETE)—The time remaining to your destination at your present speed.

Grid—A coordinate system that projects the earth on a flat surface, using square zones for position measurements.

Ground Speed (SOG)—The velocity you are traveling relative to a ground position.

Latitude—A north/south measurement of position perpendicular to the earth’s polar axis.

Longitude—An east/west measurement of position in relation to the Prime Meridian, an imaginary circle that passes through the north and south poles.

Position—An exact, unique location based on a geographic coordinate system.

Turn (TRN)— The difference and direction in degrees between the bearing to your destination and your course over ground. The TRN value is used to indicate what direction, and how many degrees, to turn to get back on course.

SECTION
E

APPENDIX
Glossary

Universal Time Coordinated (UTC)— The time of day at the prime meridian (0° longitude) in Greenwich, England.

Universal Transverse Mercator- (UTM)— A grid coordinate system that projects global sections onto a flat surface to measure position in specific zones.

Velocity Made Good (VMG)—The speed you are traveling in the direction of the destination.

Waypoint—A specific location saved in the receiver's memory.

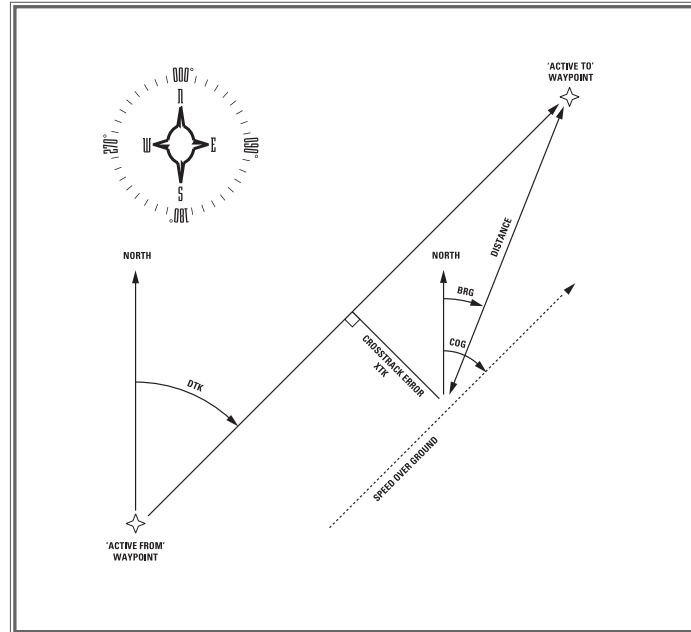

The chart below gives an approximate UTC time offset for the various longitudinal zones. Check with local charts for more detailed information. If you are in daylight savings time, add one hour to the offset.

Longitudinal Zone	Offset
W180.0° to W172.5°	-12
W172.5° to W157.5°	-11
W157.5° to W142.5°	-10
W142.5° to W127.5°	-9
W127.5° to W112.5°	-8
W112.5° to W097.5°	-7
W097.5° to W082.5°	-6
W082.5° to W067.5°	-5
W067.5° to W052.5°	-4
W052.5° to W037.5°	-3
W037.5° to W022.5°	-2
W022.5° to W007.5°	-1
W007.5° to E007.5°	0
E007.5° to E022.5°	1
E022.5° to E037.5°	2
E037.5° to E052.5°	3
E052.5° to E067.5°	4
E067.5° to E082.5°	5
E082.5° to E097.5°	6
E097.5° to E112.5°	7
E112.5° to E127.5°	8
E127.5° to E142.5°	9
E142.5° to E157.5°	10
E157.5° to E172.5°	11
E172.5° to E180.0°	12

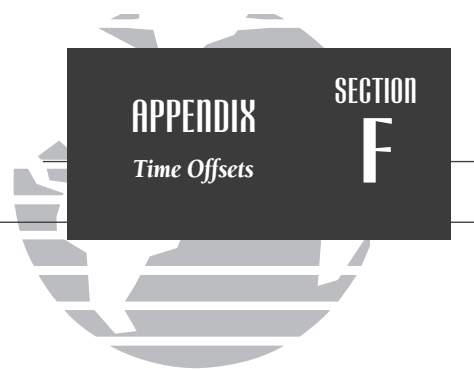

SECTION G

APPENDIX Loran TD Position Format

When creating new waypoints using Loran TD coordinates you must set the correct loran chain number and secondary stations in the Setup TD field before storing the waypoint. After the waypoint is stored in unit memory, it will always reference the loran chain number and secondary stations currently selected in the Setup TD field. If you enter a different loran chain number or change the secondary stations in the Setup TD field, the active waypoint information will reflect those changes. Since the GPSMAP 230 does not rely on the loran signal for navigation, it can reference a different GRI chain and/or secondary stations and still navigate to the location stored in memory.

NAVIGATION SETUP	
POSITION FORMAT	Loran TD Setup TD
NAVIGATION UNITS	Nautical (nm, kt, ft)
DEPTH UNITS	feet
HEADING	Auto Mag Var E002°
CDI SCALE	STEER TO ± 1.00 Center
MAP DATUM	WGS 84
VELOCITY FILTER	Auto
SIM	

LORAN SETUP	
LORAN CHAIN NUMBER	GRI_8970
SECONDARY STATION 1	GRI_9930
SECONDARY STATION 2	GRI_9007
	GRI_9610
	GRI_9930
	GRI_9940
	GRI_9960
	GRI_9990
SIM	

LORAN SETUP	
LORAN CHAIN NUMBER	GRI_8970
SECONDARY STATION 1	V
SECONDARY STATION 2	W
	X
	Y
	Z
SIM	

LORAN SETUP	
LORAN CHAIN NUMBER	GRI_8970
SECONDARY STATION 1	W
SECONDARY STATION 2	V
	W
	X
	Y
	Z
SIM	

To change the Setup TD settings::

1. Highlight the 'Setup TD' field and press **EDIT/ENTER**.
2. Select the field to change and press **EDIT/ENTER**.
3. Highlight the new setting and press **EDIT/ENTER**.



APPENDIX

SECTION

H

Index

A		Desired Track (DTK)	77
Alarm Setup	62	Depth Contours	60
Anchor Drag Alarm	62	Depth Units	60
Antenna Installation	67	Dilution of Precision (DOP)	18
Arrival Alarm	62	DGPS Setup	63-64
AutoLocate	1-2,18	DGPS Status	18
B		E	
Backlight Level	3	Entering Initial Position	2,19
Beacon Receiver Setup	63-64	Estimated Position Error (EPE)	18
Bearing	77	Estimated Time of Arrival (ETA)	29,77
Bearing/Distance Calculation	26	Estimated Time Enroute (ETE)	29,77
Built-in Map Coverage	2,74	F	
C		Full Page Mapping	26
Calibrations, Map	28	G	
Cancelling Active GOTOs	44	G-chart Cartridges	65-66
Capabilities	iii	GOTO Key	9,43-44
Cautions	ii	Ground Speed	77
Clock Alarm	62	H	
Configurations, Map	27-28	Heading Selection	60
Contrast Setting	59	I	
Countdown Timer	62	Initialization	1-2
Course Deviation Indicator (CDI)	13	Installation	67-70
Crosstrack Error	77	Interface Options	63
Cursor Mode	23-24	Interface Setup	63-64
Cursor Movement	8,24	Interval, Track Storage	55
D			
Data Field Entry	10		
Data Window	47		
Date/Time Formats	59		
Datums	74-76		
Definitions	77-78		

K		O	
Keypad Tone	59	Offset, local time	59,79
Keypad Usage	viii	Operation Mode Setup	58
		Overzoom Mode	25
L		P	
Language Setup	59	Packing List	vi
Local Time Offset	59	Page Sequence	5
Loran TD Positon Format	80	Physical Specifications	71
		Point-to-Point Planning	56
M		Position Mode	23
Magnetic Variation	60	Position Page	20-21
Main Menu	33	Position Format	60
Man Overboard Function	45	Velocity Filters	61
Map Calibration	28	Power Off	16
Map Configuration	27-28	Power On	1
Map Datum List	74-76	Proximity Alarm	41
Map Datum Selection	61	R	
Map Page	26-29	Removing G-chart Cartridges	65
Map Scales	25	Routes	47-54
Marking a Position	6,34-35	Activating A Route	50
Measuring Bearing & Distance	26	Active Route Page	14,53-54
Submenu Selection	15	Clearing	52
Message Descriptions	72-73	Copying	52
Messages, Viewing	1	Creating	47
		Deactivating	50,52,54
N		Editing By Text	49-50
Navigation Page	12-13,31-32	Editing On Map	48
Navigation Setup	60-61	Modifying Route Waypoints	48-50
Navigation Units	60	Modifying Routes	48-52
NMEA Formats	70	Moving Route Waypoints	48
NMEA Setup	63-64	Removing Route Waypoints	50
No Map Mode	25		

Reviewing Routes	48	V	
Route Comments	51	Velocity Filter	61
Route Planning Mode	57	Velocity Made Good (VMG)	32,78
Stopping Route Navigation	14		
S		W	
Satellite Acquisition	2,17-18	Waypoints	34-42
Satellite Sky View	17	Active Waypoints	53
Signal Strength Bars	2,17	Creating	34-37
Simulator Mode	4	Deleting	39
Simulator Tour	4-16	Editing By Text	38
Status Bar	18	Editing On Map	39
Status Page	17-19	Modifying	38-40
Steering Guidance	13,30-32	Moving Route Waypoints	48
Sunrise/Sunset Calculation	58	Nearest Waypoints	40
System Setup	58-59	Proximity Waypoints	41
		Reference Waypoints	37
		Removing Route Waypoints	50
T		Renaming	39
Table of Contents	vii	Reviewing	38
Time Offsets	58-59,79	Submenus	40
Timer/Alarm Setup	62	Waypoint List	42
Tone Selection	59	Wiring Installation	70
TracBack Function	45-46		
Track Log	55		
Track Memory	55		
Track Plot Resolution	55		
Track Recording	55		
Trip Odometer	20-21		
Turn (TRN)	32,77		
U			
Units of Measure	60		
UTC time	59,79		
UTM/UPS Coordinates	79		

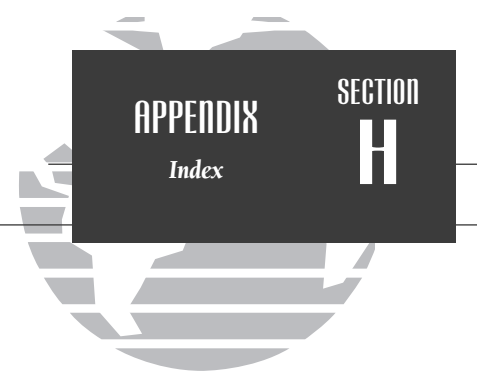



© 1999-2000 GARMIN Corporation

GARMIN International, Inc.
1200 East 151st Street, Olathe, Kansas 66062, U.S.A.

GARMIN (Europe) Ltd.
Unit 5, The Quadrangle, Abbey Park Industrial Estate, Romsey, SO51 9AQ, U.K.

GARMIN (Asia) Corporation
No. 68, Jangshu 2nd Road, Shijr, Taipei County, Taiwan

www.garmin.com

Part Number 190-00137-10 Rev. B